



STEEL SECTION AND STEEL BEAMS TECHNICAL HANDBOOK

We think holistically.

We offer our customers an integrated range of systems solutions all over the world. Key elements are the sale and hire of sheet piles, steel beams, lightweight sections and trench sheets. As a multi-supplier we provide a broad range of products from various manufacturers, supplemented by a comprehensive service package of consulting, technical support, logistics and leasing.

Content

02	Hot-rolled sheet pile sections
02	U-Sections
13	Z-Sections
17	Steel box piles
19	Combined sheet pile walls
24	Cold-rolled sheet piling sections
24	Trench sheeting
27	Lightweight sections
28	Terms of delivery and steel grades
29	Interlocks
30	Corner and junction piles for U- and Z-profiles
31	Corner and junction piles for U- and Z-profiles, traditional
32	Corner and junction piles for U- and Z-profiles, universal
33	Corner and junction piles for cold-rolled sheet piles
34	Sealing systems
34	Interlock sealing system terra Infrastructure
35	Bitumen-based interlock fillers
36	Other sealing methods
36	Criteria for selecting a suitable interlock sealing
39	Wide Flange Beam HEA
40	Wide Flange Beam HEB
41	Wide Flange Beam HEM
42	Double U Sections
43	Steel plates and sheets

Hot-rolled sheet pile sections

Overview: U-Sections

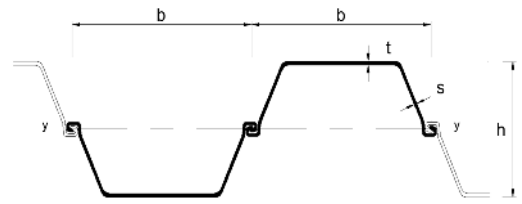

	Elastic section modulus	Plastic section modulus	Weight	Weight	Moment of inertia	Flange thickness	Web thickness	Height	Section width	Classification to DIN EN 1993-5		
	W_y cm ³ /m	$W_{y,pl}$ cm ³ /m								kg/m ²	kg/m	I_y cm ⁴ /m
tkL 601	744	895	77.2	46.3	11,530	7.5	6.4	310.0	600	2	3	3
tkL 601 FP	745	906	79.0	47.4	11,547	7.2	7.0	310.0	600	3	3	3
tkL 601 K	775	936	80.8	48.5	12,019	7.8	6.8	310.0	600	2	3	3
tkL 602 A	806	979	85.5	51.3	12,499	8.0	7.3	310.0	600	2	3	3
tkL 602	842	1022	89.0	53.4	13,046	8.4	7.6	310.0	600	2	3	3
tkL 602 K	877	1,065	92.3	55.4	13,590	8.8	7.9	310.0	600	2	2	3
tkL 603 A	1,138	1,316	102.5	61.5	18,205	9.0	8.0	320.0	600	3	4	4
tkL 603	1,200	1,386	107.0	64.2	19,199	9.6	8.2	320.0	600	3	3	4
tkL 603 KN	1,230	1,427	111.5	66.9	19,682	9.8	8.6	320.0	600	3	3	4
tkL 603 K	1,241	1,444	113.0	67.8	19,853	9.8	9.0	320.0	600	3	3	4
tkL 603 N	1,273	1,519	105.7	63.4	24,269	9.8	7.9	381.2	600	2	2	3
tkL 603 Z	1,300	1,525	120.2	72.1	20,930	10.0	10.0	322.0	600	3	3	4
tkL 603 Z11	1,404	1,653	131.0	78.6	22,470	11.0	11.0	320.0	600	2	3	3
tkL 604 A	1,564	1,823	118.3	71.0	30,495	9.6	8.8	390.0	600	3	3	4
tkL 604	1,618	1,885	121.8	73.1	31,548	10.0	9.0	390.0	600	3	3	4
tkL 604 K	1,672	1,947	125.3	75.2	32,600	10.4	9.2	390.0	600	3	3	3
tkL 605 A	1,821	2,125	127.5	76.5	38,243	10.7	9.0	420.0	600	2	3	3
tkL 605 N	2,019	2,348	136.9	82.1	42,664	12.0	9.5	422.6	600	2	2	3
tkL 606 A	2,205	2,541	142.3	85.4	47,402	13.4	9.0	430.0	600	2	2	2
tkL 606 AN	2,355	2,714	149.6	89.8	50,878	14.4	9.4	432.0	600	2	2	2
tkL 606 N	2,506	2,887	156.8	94.1	54,389	15.4	9.8	434.0	600	2	2	2
tkL 628 -1,5	2,607	3,006	158.6	95.2	58,938	14.8	9.5	452.1	600	2	2	2
tkL 628 AN	2,701	3,114	163.1	97.9	61,219	15.4	9.8	453.3	600	2	2	2
tkL 628 A	2,809	3,238	168.0	100.8	63,856	16.1	10.0	454.7	600	2	2	2
tkL 628	2,841	3,276	169.6	101.8	64,640	16.3	10.1	455.1	600	2	2	2
tkL 628 K	2,903	3,347	172.5	103.5	66,165	16.7	10.3	455.9	600	2	2	2
tkL 607 A	3,006	3,460	177.1	106.2	68,232	17.7	10.0	453.9	600	2	2	2
tkL 607	3,211	3,701	187.3	112.4	73,300	19.0	10.6	456.5	600	2	2	2
tkL 607 K	3,365	3,882	194.7	116.8	77,153	20.0	11.0	458.5	600	2	2	2

Overview: Special sections *

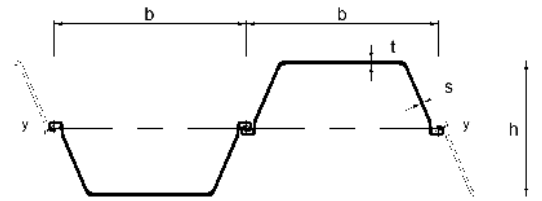

Profile	Elastic section modulus	Plastic section modulus	Weight	Weight	Moment of inertia	Flange thickness	Web thickness	Height	Section width	Classification to DIN EN 1993-5		
	Wy cm³/m	Wy,pl cm³/m	kg/m²	Single pile kg/m	Iy cm⁴/m	t mm	s mm	h mm	b mm	S 270 GP	S 355 GP	S 430 GP
tkL 602 A8	831	1,016	89.5	53.7	12,843	8.0	8.0	309.2	600	2	3	3
tkL 602 90	854	1,038	90.0	54.0	13,241	8.5	7.7	310.2	600	2	2	3
tkL 602 D	881	1,071	92.9	55.7	13,650	8.8	8.0	310.0	600	2	2	3
tkL 602 +0,5	894	1,087	93.3	56.0	13,905	8.9	8.1	311.0	600	2	2	3
tkL 602 +0,7	907	1,101	94.0	56.4	14,128	9.1	8.1	311.4	600	2	2	3
tkL 603 AN	1,161	1,342	104.0	62.4	18,601	9.2	8.1	320.4	600	3	4	4
tkL 603 108	1,215	1,404	108.0	64.8	19,456	9.7	8.3	320.2	600	3	3	4
tkL 603 K10	1,261	1,465	114.1	68.4	20,196	10.0	9.0	320.4	600	3	3	4
tkL 604 AN	1,409	1,637	107.1	64.3	27,478	8.7	7.7	390.0	600	3	4	4
tkL 604 124	1,659	1,932	124.0	74.4	32,407	10.3	9.1	390.6	600	3	3	3
tkL 605 A +0,5	1,885	2,194	130.1	78.1	39,681	11.2	9.0	421.0	600	2	3	3
tkL 605 N 1975	1,975	2,299	134.8	80.9	41,681	11.7	9.4	422.0	600	2	3	3
tkL 605 N 2020	2,020	2,350	137.0	82.2	42,684	12.0	9.5	422.6	600	2	2	3
tkL 605 N 138,5	2,050	2,384	138.5	83.1	43,362	12.2	9.6	423.0	600	2	2	3
tkL 605 N 139,2	2,065	2,401	139.2	83.5	43,699	12.3	9.6	423.2	600	2	2	3
tkL 605 K	2,068	2,414	142.9	85.7	43,434	12.4	10.0	420.0	600	2	2	3
tkL 605 N +0,5	2,094	2,433	140.5	84.3	44,350	12.5	9.7	423.6	600	2	2	3
tkL 606 AS +0,5	2,228	2,578	144.9	87.0	47,898	13.4	9.5	430.0	600	2	2	2
tkL 606 A +0,5	2,269	2,611	144.9	86.9	48,893	13.9	9.0	431.0	600	2	2	2
tkL 606 AN 10	2,402	2,778	153.4	92.0	51,913	14.5	10.0	432.2	600	2	2	2
tkL 606 N 157	2,517	2,897	157.0	94.3	54,645	15.5	9.8	434.2	600	2	2	2
tkL 504 A	1,423	1,677	127.0	63.5	24,198	11.2	8.7	340.0	500	2	2	2
tkL 504	1,504	1,771	133.2	66.6	25,575	12.0	9.0	340.0	500	2	2	2
tkL 504 K	1,602	1,885	140.6	70.3	27,233	13.0	9.3	340.0	500	2	2	2
tkL 507 A	2,800	3,275	184.6	92.3	61,185	17.5	10.2	437.0	500	2	2	2
tkL III n	1,600	1,857	155.5	62.2	23,206	13.0	9.0	290.0	400	2	2	2

* Only on request

Details: U-Sections

Section

S = Single pile
 D = Double pile
 T = Triple pile

Profile	Elastic section modulus Wy cm ³	Weight kg/m	Cross sectional area cm ²	Coating area m ² /m	Static moment Sy cm ³	Moment of inertia ly cm ⁴	Radius of gyration cm	
	per m wall	744	77.2	98.3	2.57	448	11,530	10.83
	per S	221	46.3	59.0	1.60		2,360	6.32
	per D	893	92.6	118.0	3.08		13,836	10.83
	per T	1,044	138.9	177.0	4.56		19,235	10.42
	per m wall	745	79.0	100.7	2.57	453	11,547	10.70
	per S	223	47.4	60.4	1.60		2,360	6.25
	per D	894	94.8	120.8	3.08		13,857	10.70
	per T	1,047	142.3	181.2	4.56		19,262	10.30
	per m wall	775	80.8	102.9	2.57	468	12,019	10.81
	per S	229	48.5	61.8	1.60		2,457	6.31
	per D	931	97.0	123.5	3.08		14,423	10.81
	per T	1,088	145.5	185.3	4.56		20,050	10.40
	per m wall	806	85.5	109.0	2.57	490	12,499	10.71
	per S	245	51.3	65.4	1.60		2,601	6.31
	per D	968	102.6	130.7	3.08		14,998	10.71
	per T	1,135	153.9	196.1	4.57		20,865	10.31
	per m wall	842	89.0	113.3	2.57	511	13,046	10.73
	per S	252	53.4	68.0	1.60		2,698	6.30
	per D	1,010	106.8	136.0	3.08		15,655	10.73
	per T	1,184	160.2	204.0	4.57		21,773	10.28
	per m wall	877	92.3	117.7	2.57	533	13,590	10.75
	per S	260	55.4	70.6	1.60		2,797	6.29
	per D	1,052	110.8	141.2	3.08		16,308	10.75
	per T	1,232	166.2	211.8	4.56		22,676	10.35

1. The elastic section modulus of the U-profiles may only be applied in the static calculation if at least every second interlock is crimped and welded to absorb the shear forces
2. Elastic section modulus: for S and T related to the axis of gravity of the respective element, for D and per m wall related to the wall axis y-y
3. The coating surfaces correspond to the surfaces on both sides, without the interlock!!

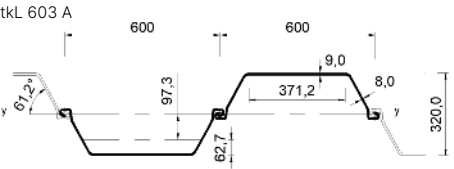
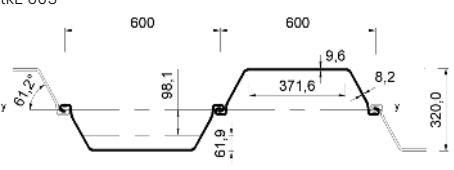
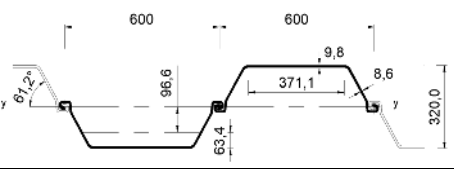
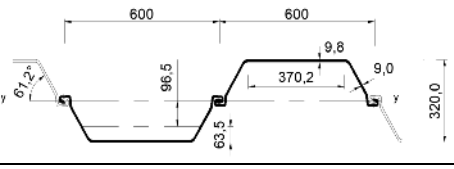
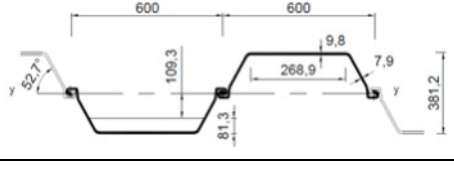
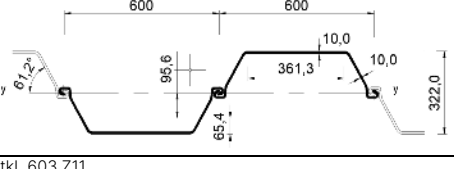
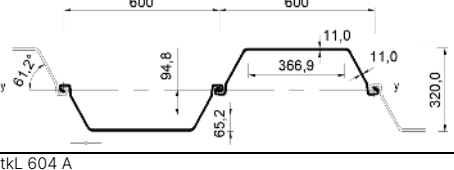
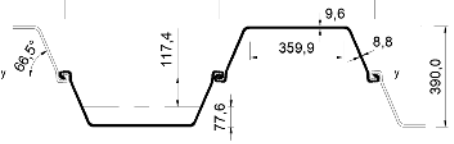
		Elastic section modulus Wy cm ³	Weight kg/m	Cross sectional area cm ²	Coating area m ² /m	Static moment Sy cm ³	Moment of inertia ly cm ⁴	Radius of gyration cm
tkL 603 A 	per m wall	1,138	102.5	130.6	2.76	658	18,205	11.81
	per S	296	61.5	78.3	1.72		3,503	6.69
	per D	1,365	123.0	156.7	3.31		21,846	11.81
	per T	1,574	184.5	235.0	4.90		30,296	11.35
tkL 603 	per m wall	1,200	107.0	136.3	2.76	693	19,199	11.87
	per S	304	64.2	81.8	1.73		3,641	6.67
	per D	1,440	128.4	163.6	3.31		23,039	11.87
	per T	1,657	192.6	245.3	4.90		31,933	11.41
tkL 603 KN 	per m wall	1,230	111.5	142.0	2.77	713	19,682	11.77
	per S	324	66.9	85.2	1.73		3,856	6.73
	per D	1,476	133.7	170.4	3.32		23,618	11.77
	per T	1,705	200.6	255.6	4.90		32,776	11.32
tkL 603 K 	per m wall	1,240	113.0	143.9	2.77	722	19,853	11.74
	per S	326	67.8	86.4	1.73		3,873	6.70
	per D	1,489	135.6	172.7	3.32		23,824	11.74
	per T	1,720	203.4	259.1	4.90		33,056	11.30
tkL 603 N 	per m wall	1,237	105.7	134.6	2.75	760	24,269	13.43
	per S	375	63.4	80.8	1.70		4,908	7.80
	per D	1,528	126.8	161.5	3.30		29,123	12.92
	per T	1,782	190.2	242.3	4.89		40,467	13.43
tkL 603 Z 	per m wall	1,300	120.2	153.1	2.77	763	20,930	11.69
	per S	350	72.1	91.9	1.73		4,162	6.73
	per D	1,560	144.2	183.7	3.32		25,115	11.69
	per T	1,808	216.3	275.6	4.91		34,874	11.25
tkL 603 Z11 	per m wall	1,404	131.0	166.9	2.77	827	22,470	11.60
	per S	375	78.6	100.2	1.73		4,472	6.68
	per D	1,685	157.2	200.3	3.32		26,964	11.60
	per T	1,954	235.8	300.5	4.90		37,443	11.16
tkL 604 A 	per m wall	1,564	118.3	150.8	2.98	912	30,495	14.22
	per S	418	71.0	90.5	1.85		5,834	8.03
	per D	1,877	142.0	181.0	3.58		36,594	14.22
	per T	2,167	213.0	271.5	5.31		50,737	13.67

1. The elastic section modulus of the U-profiles may only be applied in the static calculation if at least every second interlock is crimped and welded to absorb the shear forces
2. Elastic section modulus: for S and T related to the axis of gravity of the respective element, for D and per m wall related to the wall axis y-y
3. The coating surfaces correspond to the surfaces on both sides, without the interlock!

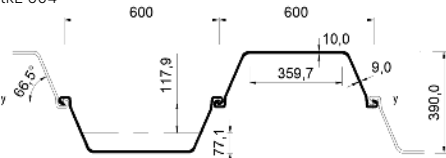
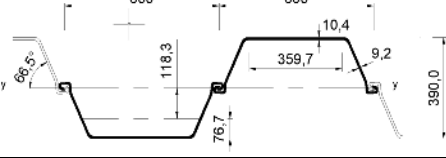
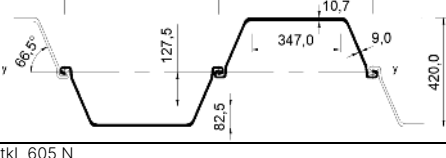
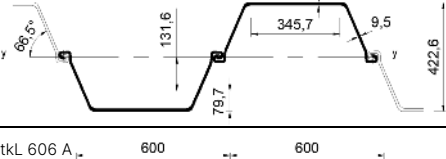
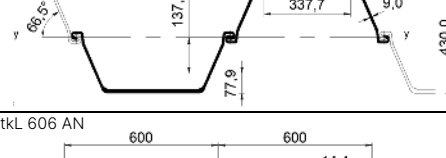
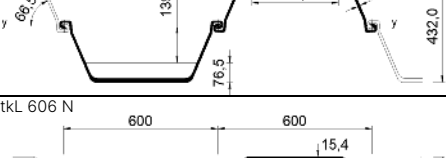
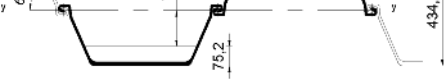
		Elastic section modulus Wy cm ³	Weight kg/m	Cross sectional area cm ²	Coating area m ² /m	Static moment Sy cm ³	Moment of inertia Iy cm ⁴	Radius of gyration cm
tkL 604 	per m wall	1,618	121.8	155.2	2.97	943	31,548	14.26
	per S	426	73.1	93.1	1.85		5,984	8.02
	per D	1941	146.2	186.2	3.56		37,857	14.26
	per T	2,240	219.3	279.4	5.27		52,471	13.70
tkL 604 K 	per m wall	1,672	125.3	159.7	2.97	974	32,600	14.29
	per S	435	75.2	95.8	1.85		6,140	8.00
	per D	2,006	150.4	191.7	3.56		39,121	14.29
	per T	2,312	225.6	287.5	5.27		54,207	13.73
tkL 605 A 	per m wall	1,821	127.5	162.5	3.03	1,063	38,243	15.34
	per S	475	76.5	97.5	1.89		7,113	8.54
	per D	2,185	153.0	194.9	3.64		45,892	15.34
	per T	2,517	229.5	292.4	5.39		63,560	14.74
tkL 605 N 	per m wall	2,019	136.9	174.4	3.02	1,174	42,664	15.64
	per S	486	82.1	104.6	1.88		7,488	8.46
	per D	2,423	164.2	209.2	3.62		51,197	15.64
	per T	2,773	264.4	313.8	5.36		70,759	15.02
tkL 606 A 	per m wall	2,205	142.3	181.3	3.04	1,271	47,402	16.17
	per S	500	85.4	108.8	1.90		7,981	8.56
	per D	2,646	170.8	217.6	3.65		56,883	16.17
	per T	3,011	256.2	326.4	5.41		78,504	15.51
tkL 606 AN 	per m wall	2,355	149.6	190.6	3.04	1,357	50,878	16.33
	per S	512	89.8	114.4	1.89		8,281	8.51
	per D	2,827	179.6	228.8	3.65		61,056	16.33
	per T	3,207	269.5	343.3	5.40		84,168	15.66
tkL 606 N 	per m wall	2,506	156.8	199.8	3.03	1,443	54,389	16.50
	per S	520	94.1	119.9	1.89		8,545	8.44
	per D	3,008	188.2	239.7	3.65		65,266	16.50
	per T	3,401	282.3	359.6	5.40		89,870	15.81

1. The elastic section modulus of the U-profiles may only be applied in the static calculation if at least every second interlock is crimped and welded to absorb the shear forces
2. Elastic section modulus: for S and T related to the axis of gravity of the respective element, for D and per m wall related to the wall axis y-y
3. The coating surfaces correspond to the surfaces on both sides, without the interlock!

		Elastic section modulus Wy cm³	Weight kg/m	Cross sectional area cm²	Coating area m²/m	Static moment Sy cm³	Moment of inertia ly cm⁴	Radius of gyration cm
tkL 628 -1,5 	per m wall	2,607	158.6	202.0	3.05	1,503	58,938	17.08
	per S	567	95.2	121.2	1.88		9,560	8.88
	per D	3,129	190.3	242.4	3.66		70,725	17.08
	per T	3,549	285.5	363.6	5.44		97,487	16.37
tkL 628 AN 	per m wall	2,701	163.1	207.8	3.05	1,557	61,219	17.17
	per S	575	97.9	124.7	1.88		9,763	8.85
	per D	3,241	195.7	249.3	3.66		73,462	17.17
	per T	3,671	293.6	374.0	5.44		101,204	16.45
tkL 628 A 	per m wall	2,809	168.0	214.0	3.05	1,619	63,856	17.27
	per S	582	100.0	128.4	1.88		9,973	8.81
	per D	3,370	201.6	256.8	3.66		76,627	17.29
	per T	3,810	302.4	385.2	5.44		105,494	16.55
tkL 628 	per m wall	2,841	169.6	216.1	3.05	1,638	64,640	17.29
	per S	586	101.8	129.7	1.88		10,053	8.81
	per D	3,409	203.6	259.3	3.66		77,568	17.29
	per T	3,852	305.4	389.0	5.44		106,775	16.57
tkL 628K 	per m wall	2,903	172.5	219.8	3.05	1,674	66,165	17.35
	per S	590	103.5	131.9	1.88		10,173	8.78
	per D	3,483	207.0	263.7	3.66		79,398	17.35
	per T	3,932	310.5	395.6	5.44		109,205	16.62
tkL 607A 	per m wall	3,006	177.1	225.6	3.13	1,730	68,232	17.39
	per S	586	106.2	135.3	1.95		10,164	8.67
	per D	3,608	212.5	270.7	3.75		81,879	17.39
	per T	4,060	318.7	406.0	5.54		112,560	16.65
tkL 607 	per m wall	3,211	187.3	238.6	3.13	1,851	73,300	17.53
	per S	605	112.4	143.2	1.95		10,617	8.61
	per D	3,854	224.8	286.3	3.75		87,960	17.53
	per T	4,328	337.1	429.5	5.54		120,819	16.77
tkL 607K 	per m wall	3,365	194.7	248.0	3.13	1,941	77,153	17.64
	per S	617	116.8	148.8	1.95		10,920	8.57
	per D	4,038	233.6	297.5	3.75		92,583	17.64
	per T	4,528	350.4	446.3	5.54		127,084	16.87

1. The elastic section modulus of the U-profiles may only be applied in the static calculation if at least every second interlock is crimped and welded to absorb the shear forces
2. Elastic section modulus: for S and T related to the axis of gravity of the respective element, for D and per m wall related to the wall axis y-y
3. The coating surfaces correspond to the surfaces on both sides, without the interlock!

Details: Special sections *

		Elastic section modulus Wy cm ³	Weight kg/m	Cross sectional area cm ²	Coating area m ² /m	Static moment Sy cm ³	Moment of inertia Iy cm ⁴	Radius of gyration cm	
tkL 602A8		per m wall	831	89.5	114.0	2.57	508	12,843	10.61
		per S	252	53.7	68.4	1.60		2,668	6.25
		per D	997	107.4	136.8	3.08		15,411	10.61
		per T	1,170	161.1	205.2	4.56		21,438	10.22
tkL 602 90		per m wall	854	90.0	114.7	2.57	519	13,241	10.74
		per S	253	54.0	68.8	1.60		2,720	6.29
		per D	1,024	108.1	137.6	3.08		15,890	10.74
		per T	1,200	162.1	206.5	4.57		22,093	10.34
tkL 602D		per m wall	881	92.9	118.3	2.57	536	13,650	10.74
		per S	260	55.7	71.0	1.60		2,802	6.28
		per D	1,057	111.4	142.0	3.08		16,380	10.74
		per T	1,238	167.2	213.0	4.56		22,774	10.34
tkL 602 +0,5		per m wall	894	93.3	118.8	2.57	543	13,905	10.82
		per S	257	56.0	71.3	1.60		2,789	6.26
		per D	1,073	112.0	142.6	3.08		16,686	10.82
		per T	1,253	168.0	213.9	4.57		23,178	10.41
tkL 602 +0,7		per m wall	907	94.0	119.8	2.57	551	14,128	10.86
		per S	259	56.4	71.9	1.60		2,819	6.26
		per D	1,089	112.9	143.8	3.08		16,954	10.86
		per T	1,271	169.3	215.7	4.56		23,545	10.45
tkL 603AN		per m wall	1,161	104.0	132.4	2.76	671	18,601	11.85
		per S	298	62.4	79.5	1.72		3,539	6.67
		per D	1,393	124.7	158.9	3.31		22,321	11.85
		per T	1,604	187.1	238.4	4.90		30,941	11.39
tkL 603 108		per m wall	1,215	108.0	137.7	2.77	702	19,456	11.89
		per S	305	64.8	82.6	1.73		3,663	6.66
		per D	1,458	129.7	165.2	3.32		23,347	11.89
		per T	1,677	194.5	247.8	4.90		32,351	11.43

* Only on request

1. The elastic section modulus of the U-profiles may only be applied in the static calculation if at least every second interlock is crimped and welded to absorb the shear forces
2. Elastic section modulus: for S and T related to the axis of gravity of the respective element, for D and per m wall related to the wall axis y-y
3. The coating surfaces correspond to the surfaces on both sides, without the interlock!

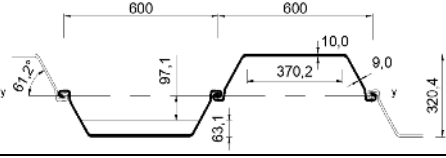
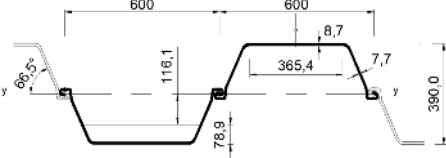
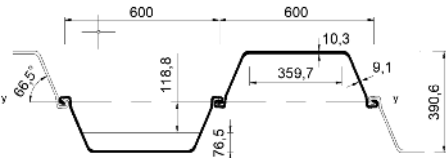
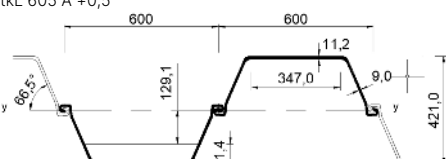
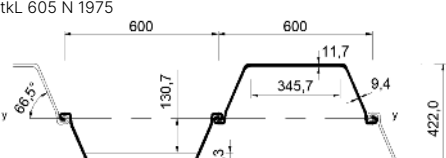
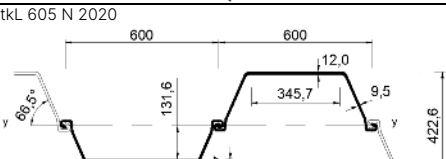
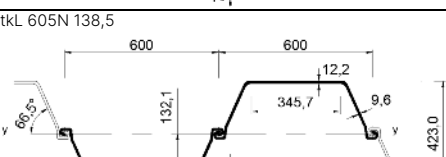
		Elastic section modulus Wy cm ³	Weight kg/m	Cross sectional area cm ²	Coating area m ² /m	Static moment Sy cm ³	Moment of inertia ly cm ⁴	Radius of gyration cm
tkL 603K10 	per m wall	1,261	114.1	145.3	2.88	732	20196	11.79
	per S	327	68.4	87.2	1.73		3905	6.69
	per D	1513	136.9	174.4	3.32		24235	11.79
	per T	1746	205.3	261.5	4.91		33617	11.34
tkL 604 AN 	per m wall	1,409	107.1	136.5	2.98	819	27,478	14.19
	per S	393	64.3	81.9	1.85		5,438	8.15
	per D	1,691	128.6	163.8	3.58		32,973	14.19
	per T	1,959	192.8	245.7	5.31		45,776	13.65
tkL 604 124 	per m wall	1,659	124.0	158.0	2.97	966	32,407	14.32
	per S	430	74.4	94.8	1.85		6,070	8.00
	per D	1,991	148.8	189.5	3.56		38,888	14.32
	per T	2,294	223.2	284.3	5.27		53,874	13.77
tkL 605 A +0,5 	per m wall	1,885	130.1	165.7	3.03	1,097	39,681	15.47
	per S	478	78.1	99.4	1.89		7,244	8.54
	per D	2,262	156.1	198.9	3.64		47,618	15.47
	per T	2,600	234.2	298.3	5.39		65,905	14.86
tkL 605 N 1975 	per m wall	1,975	134.8	171.7	3.02	1,150	41,681	15.58
	per S	483	80.9	103.0	1.88		7,401	8.48
	per D	2,370	161.8	206.1	3.62		50,017	15.58
	per T	2,717	242.7	309.1	5.36		69,157	14.96
tkL 605 N 2020 	per m wall	2,020	137.0	174.5	3.02	1,175	42,684	15.64
	per S	486	82.2	104.7	1.88		7,491	8.46
	per D	2,424	164.4	209.4	3.62		51,220	15.64
	per T	2,774	246.6	314.1	5.36		70,791	15.01
tkL 605N 138,5 	per m wall	2,050	138.5	176.4	3.02	1,192	43,362	15.68
	per S	489	83.1	105.8	1.88		7,554	8.45
	per D	2,460	166.2	211.7	3.62		52,034	15.68
	per T	2,814	249.2	317.5	5.36		71,897	15.05

1. The elastic section modulus of the U-profiles may only be applied in the static calculation if at least every second interlock is crimped and welded to absorb the shear forces
2. Elastic section modulus: for S and T related to the axis of gravity of the respective element, for D and per m wall related to the wall axis y-y
3. The coating surfaces correspond to the surfaces on both sides, without the interlock!

		Elastic section modulus Wy cm ³	Weight kg/m	Cross sectional area cm ²	Coating area m ² /m	Static moment Sy cm ³	Moment of inertia ly cm ⁴	Radius of gyration cm
tkL 605 N 139,2 	per m wall	2,065	139.2	177.3	3.02	1,200	43,699	15.70
	per S	490	83.5	106.4	1.88		7,583	8.44
	per D	2,478	167.0	212.8	3.62		52,439	15.70
	per T	2,833	250.5	319.2	5.36		72,446	15.07
tkL 605K 	per m wall	2,068	142.9	182.0	3.03	1,207	43,434	15.45
	per S	512	85.7	109.2	1.89		7,821	8.46
	per D	2,482	171.4	218.4	3.64		52,121	15.45
	per T	2,849	257.2	327.7	5.38		72,102	14.83
tkL 605 N +0,5 	per m wall	2,094	140.5	179.0	3.02	1,217	44,350	15.74
	per S	491	84.3	107.4	1.88		7,636	8.43
	per D	2,513	168.6	214.8	3.62		53,220	15.74
	per T	2,870	252.9	322.1	5.36		73,504	15.11
tkL 606 AS +0,5 	per m wall	2,228	144.9	184.6	3.04	1,289	47,898	16.11
	per S	506	87.0	110.8	1.90		8,048	8.52
	per D	2,673	173.9	221.5	3.65		57,477	16.11
	per T	3,044	260.9	332.3	5.41		79,319	15.45
tkL 606 A +0,5 	per m wall	2,269	144.9	184.6	3.04	1,305	48,893	16.28
	per S	503	86.9	110.7	1.90		8,096	8.55
	per D	2,723	173.9	221.5	3.65		58,672	16.28
	per T	3,093	260.8	332.2	5.41		80,930	15.61
tkL 606 AN 10 	per m wall	2,402	153.4	195.4	3.04	1,389	51,913	16.30
	per S	517	92.0	117.2	1.89		8,373	8.45
	per D	2,883	184.0	234.4	3.65		62,295	16.30
	per T	3,270	276.0	351.6	5.40		85,852	15.63
tkL 606 N 157 	per m wall	2,517	157.0	200.1	3.04	1,449	54,645	16.53
	per S	520	94.3	120.1	1.89		8,560	8.44
	per D	3,020	188.5	240.1	3.65		65,574	16.53
	per T	3,414	282.8	360.2	5.40		90,286	15.83

1. The elastic section modulus of the U-profiles may only be applied in the static calculation if at least every second interlock is crimped and welded to absorb the shear forces
2. Elastic section modulus: for S and T related to the axis of gravity of the respective element, for D and per m wall related to the wall axis y-y
3. The coating surfaces correspond to the surfaces on both sides, without the interlock!

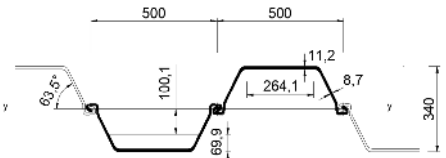
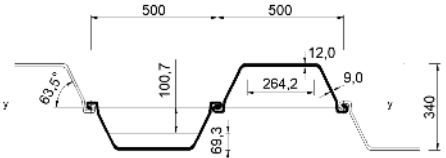
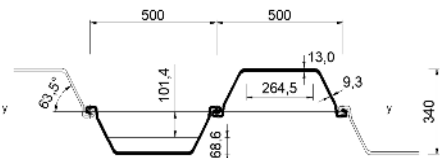
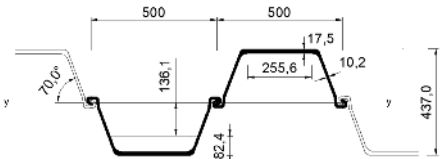
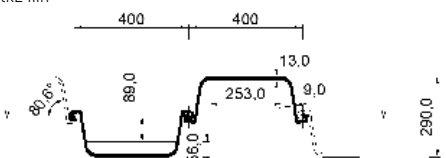
		Elastic section modulus Wy cm ³	Weight kg/m	Cross sectional area cm ²	Coating area m ² /m	Static moment Sy cm ³	Moment of inertia Iy cm ⁴	Radius of gyration cm	
tkL 504A		per m wall	1,423	127.0	161.7	2.98	838	24,198	12.23
		per S	329	63.5	80.9	1.56		3,993	7.30
		per D	1,423	127.0	161.7	2.98		24,198	12.23
		per T	1,652	190.5	242.6	4.40		33,596	11.77
tkL 504		per m wall	1,504	133.2	169.7	2.98	886	25,575	12.28
		per S	341	66.6	84.8	1.56		4,181	7.20
		per D	1,504	133.2	169.7	2.98		25,575	12.28
		per T	1,744	199.8	254.5	4.40		35,493	11.81
tkL 504 K		per m wall	1,602	140.6	179.1	2.98	942	27,233	12.33
		per S	355	70.3	89.6	1.56		4,408	7.20
		per D	1,602	140.6	179.1	2.98		27,233	12.33
		per T	1,854	210.9	268.7	4.40		37,780	11.86
tkL 507 A		per m wall	2,800	184.6	235.2	3.32	1,638	61,185	16.13
		per S	554	92.3	117.6	1.73		8,797	8.65
		per D	2,800	184.6	235.2	3.32		61,185	16.13
		per T	3,203	276.9	352.8	4.91		84,512	15.48
tkL III n		per m wall	1,600	155.5	198.1	3.28	928	23,206	10.82
		per S	255	62.2	79.3	1.38		2,849	5.99
		per D	1,280	124.4	158.5	2.62		18,565	10.82
		per T	1,469	186.6	237.8	3.88		25,703	10.40

1. The elastic section modulus of the U-profiles may only be applied in the static calculation if at least every second interlock is crimped and welded to absorb the shear forces
2. Elastic section modulus: for S and T related to the axis of gravity of the respective element, for D and per m wall related to the wall axis y-y
3. The coating surfaces correspond to the surfaces on both sides, without the interlock!!

Conformity assessments

Certificate of conformity (Ü-Sign, ÜHP);
 Proof of conformity for products of the building industry
 according to regulation Bauregelliste 4

Interlock forms, shapes of supply, handling holes and interlocking

Interlock

U-Section (LARSSEN interlock)

Interlock according DIN EN 10248-2 and EAU 2020



Shape of supply

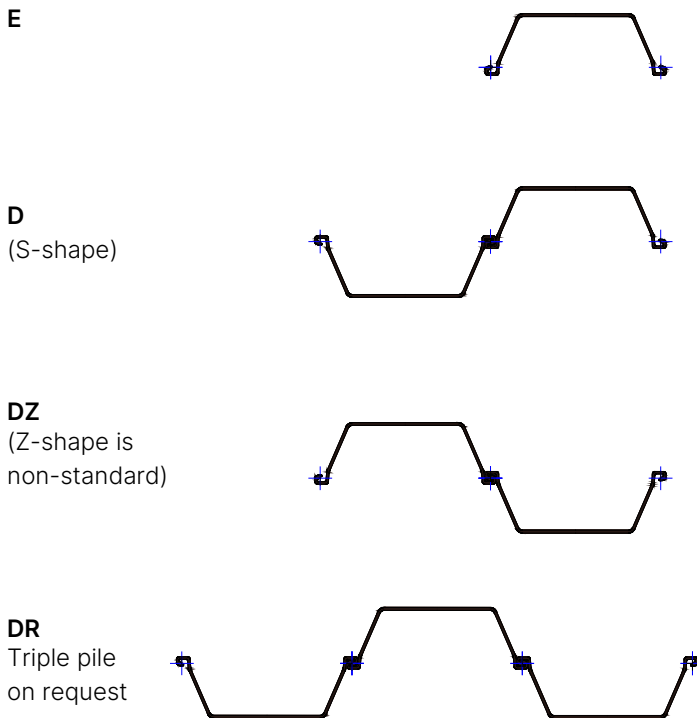

Handling holes and crimping/welding

Handling holes can be cut on request. They are cut in every pile flange according to the drawing below. The distance of the hole from the top edge is 75 or 300 mm (diameter 40mm) and must be specified with the order. Factory crimping, factory shear-resistant welding, or site welding of the interlocks is required to achieve the section moduli of the U-sections specified in this publication. Crimped double piles are delivered with triple crimping points spaced approx. 0.6 m apart. Closer spacing can be specified for crimping points and handling holes on request. The loadbearing capacity of each triple crimping point is min. 75 kN for a mutual displacement of 5 mm. On request sheet piling can also be provided with shear-resistant welding.

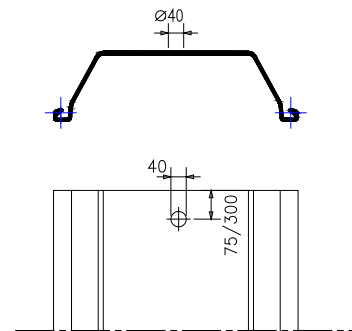

Overview: Z-Sections

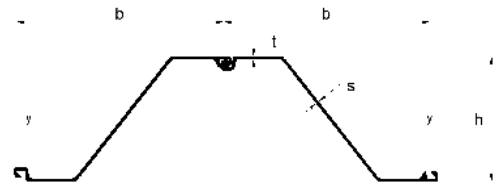

Profile	Elastic section modulus	Plastic section modulus	Weight	Weight	Moment of inertia	Flange thickness	Web thickness	Height	Section width	Classification to DIN EN 1993-5		
	W_y cm ³	$W_{y,pl}$ cm ³	kg/m ²	Einzelbohle kg/m	I_y cm ⁴ /m	t mm	s mm	h mm	b mm	S 270 GP	S 355 GP	S 430 GP
Hoesch 1208	1,301	1,540	95.0	73.2	22,995	8.5	8.5	354.0	770	3	3	3
Hoesch 1308	1,357	1,609	99.5	76.6	24,013	9.0	9.0	354.0	770	2	3	3
Hoesch 1408	1,412	1,678	104.0	80.1	25,030	9.5	9.5	355.0	770	2	2	3
Hoesch 1707	1,731	2,031	104.6	73.2	36,304	8.5	8.5	420.0	700	3	3	3
Hoesch 1807	1,804	2,121	109.5	76.7	37,894	9.0	9.0	420.0	700	2	3	3
Hoesch 1907	1,878	2,212	114.5	80.1	39,485	9.5	9.5	421.0	700	2	3	3
Hoesch 2007	1,951	2,303	119.4	83.6	41,076	10.0	10.0	421.0	700	2	3	3
Hoesch 2407	2,432	2,819	135.9	95.1	53,379	11.0	11.0	439.0	700	2	3	3
Hoesch 2607	2,606	3,030	146.5	102.5	57,329	12.0	12.0	440.0	700	2	2	3
Hoesch 2807	2,779	3,241	157.0	109.9	61,279	13.0	13.0	441.0	700	2	2	2
Hoesch 3607	3,600	4,111	168.8	118.1	89,826	17.0	11.0	499.0	700	2	2	2
Hoesch 3807	3,800	4,357	179.9	125.9	95,004	18.0	12.0	500.0	700	2	2	2
Hoesch 4007	3,999	4,604	191.0	133.7	100,184	19.0	13.0	501.0	700	2	2	2

Details: Z-Sections

Sections

S = Single pile

D = Double pile

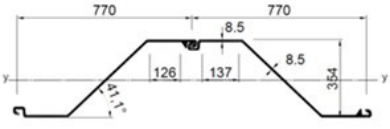
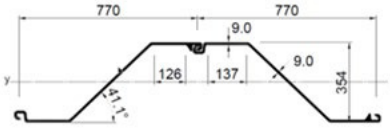
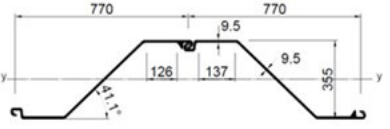
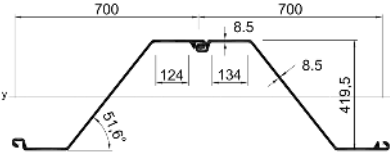
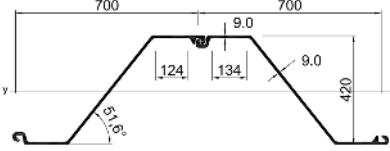
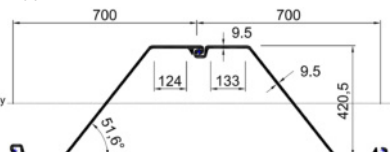
		Elastic section modulus Wy cm ³	Weight kg/m	Cross sectional area cm ²	Coating area m ² /m	Static moment Sy cm ³	Moment of inertia Iy cm ⁴	Radius of gyration cm
Hoesch 1208 	per m wall	1,301	95.0	121.0	1.21	770	22,995	13.78
	per S	1,000	73.2	93.2	0.93		17,707	13.78
	per D	2,004	146.3	186.4	1.87		35,413	13.78
Hoesch 1308 	per m wall	1,357	99.5	126.8	1.21	805	24,013	13.76
	per S	1,043	76.6	97.60	0.93		18,490	13.76
	per D	2,089	153.2	195.2	1.87		36,980	13.76
Hoesch 1408 	per m wall	1,412	104.0	132.5	1.21	839	25,030	13.74
	per S	1,086	80.1	102.0	0.93		17,773	13.74
	per D	2,175	160.1	204.0	1.87		35,546	13.74
Hoesch 1707 	per m wall	1,731	104.6	133.2	1.33	1,015	36,304	16.51
	per S	1,209	73.2	93.3	0.93		25,413	16.51
	per D	2,423	146.4	186.5	1.87		50,826	16.51
Hoesch 1807 	per m wall	1,804	109.5	139.5	1.33	1,060	37,894	16.48
	per S	1,261	76.7	97.7	0.93		26,526	16.48
	per D	2,526	153.3	195.3	1.87		53,052	16.48
Hoesch 1907 	per m wall	1,878	114.5	145.9	1.33	1,106	39,485	16.45
	per S	1,313	80.1	102.1	0.93		27,640	16.45
	per D	2,629	160.3	204.2	1.87		55,279	16.45

1. The coating surfaces correspond to the surfaces on both sides, without the interlock!!

		Elastic section modulus W_y cm ³	Weight kg/m	Cross sectional area cm ²	Coating area m ² /m	Static moment S_y cm ³	Moment of inertia I_y cm ⁴	Radius of gyration cm
Hoesch 2007 	per m wall	1,951	119.4	152.2	1.33	1,151	41,076	16.43
	per S	1,366	83.6	106.5	0.93		28,754	16.43
	per D	2,732	167.2	213.0	1.87		57,507	16.43
Hoesch 2407 	per m wall	2,432	135.9	173.1	1.39	1,410	53,379	17.56
	per S	1,701	95.1	121.2	0.97		37,365	17.56
	per D	3,405	190.2	242.4	1.95		74,730	17.56
Hoesch 2607 	per m wall	2,606	146.5	186.6	1.39	1,515	57,329	17.53
	per S	1,824	102.5	130.6	0.97		40,130	17.53
	per D	3,648	205.0	261.2	1.95		80,260	17.53
Hoesch 2807 	per m wall	2,779	157.0	200.0	1.39	1,620	61,279	17.50
	per S	1,945	109.9	140.0	0.97		42,896	17.50
	per D	3,891	219.8	280.0	1.95		85,791	17.50
Hoesch 3607 	per m wall	3,600	168.8	215.0	1.45	2,055	89,826	20.44
	per S	2,515	118.1	150.5	1.02		62,878	20.44
	per D	5,040	236.3	301.1	2.03		125,757	20.44
Hoesch 3807 	per m wall	3,800	179.9	229.2	1.45	2,179	95,004	20.36
	per S	2,654	125.9	160.4	1.02		66,503	20.36
	per D	5,320	251.9	320.9	2.03		133,006	20.36
Hoesch 4007 	per m wall	3,999	191.0	243.3	1.45	2,302	100,184	20.29
	per S	2,792	133.7	170.3	1.02		70,128	20.29
	per D	5,599	267.4	340.7	2.03		140,258	20.29

The coating surfaces correspond to the surfaces on both sides, without the interlock!

Conformity assessments

Certificate of conformity (Ü-Zeichen, ÜHP);

Proof of conformity for products of the building industry according to regulation Bauregelliste 4

Interlock forms, shapes of supply, handling holes and interlocking

Interlock

Z-Section (LARSSEN interlock)

Interlock according DIN EN 10248-2 and EAU 2020



Handling holes and crimping/welding

every pile flange according to the drawing below. The distance of the hole from the top edge is 75 or 300 mm and must be specified with the order. Crimping/welding of double piles on request.

Shape of supply

Eb



Ea

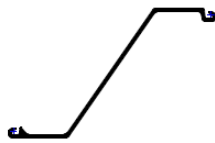

Db

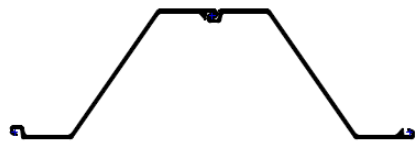

Da

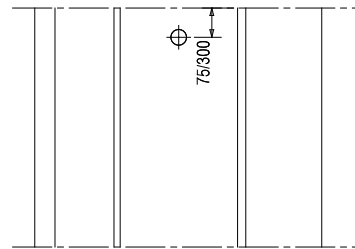
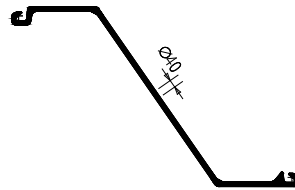
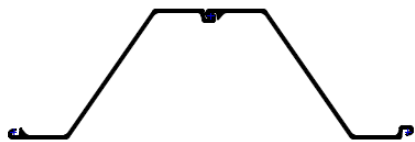

Steel box piles

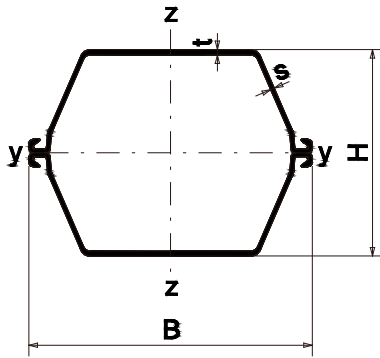

Pile sections	Section modulus W_y cm^3	Section modulus W_z cm^3	Weight kg/m	b mm	h mm	Dimensions		Perimeter cm	Area Steel cross section cm^2	Moment of inertia I_y cm^4	Moment of inertia I_z cm^4	Radius of gyration $min.i$ cm
						t mm	s mm					
terra Infrastructure LP												
LP 601	1,047	1,532	92.6	632	348	7.5	6.4	188	118.0	18,229	48,407	12.43
LP 602	1,197	1,771	106.8	633	350	8.4	7.6	188	136.0	20,976	56,067	12.42
LP 603	1,692	2,209	128.4	638	363	9.6	8.2	202	163.6	30,718	70,370	13.70
LP 603 Z	1,863	2,554	144.2	638	369	10.0	10.0	202	183.7	34,350	81,479	13.67
LP 604 A	2,161	2,525	142.0	638	435	9.6	8.8	214	181.0	46,946	80,555	16.10
LP 604	2,238	2,582	146.2	638	435	10.0	9.0	214	186.3	48,661	82,354	16.16
LP 605 N	2,764	2,753	164.2	638	467	12.0	9.5	219	209.2	64,607	87,814	17.57
LP 605 KN	2,898	2,848	171.2	638	469	12.6	10.0	219	218.1	67,950	90,864	17.65
LP 606 A	3,006	2,748	170.8	638	475	13.4	9.0	219	217.6	71,383	87,654	18.11
LP 606 N	3,414	2,925	188.2	638	479	15.4	9.8	220	239.7	81,740	93,307	18.47
LP 628	3,854	3,127	203.6	638	501	16.3	10.1	224	259.3	96,479	99,740	19.29
LP 607 A	4,033	3,193	212.4	638	499	17.7	10.0	222	270.7	100,704	101,843	19.29
LP 607	4,190	3,427	224.8	638	502	19.0	10.6	223	286.3	105,163	109,326	19.17
LP 607 K	4,290	3,605	233.6	638	504	20.0	11.0	223	297.5	108,118	114,994	19.06

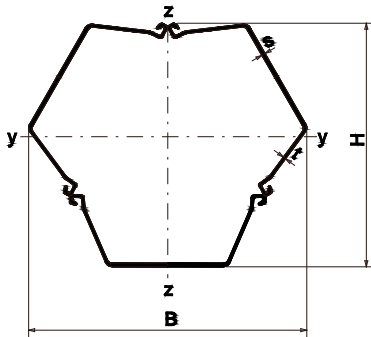

terra Infrastructure LD												
LD 601	3,000	2,999	138.9	745	724	7.5	6.4	278	177.0	111,704	111,704	25.12
LD 602	3,457	3,454	204.0	747	727	8.4	7.6	279	204.0	129,056	129,056	25.15
LD 603	4,450	4,097	192.6	818	737	9.6	8.2	299	245.3	167,522	167,522	26.13
LD 603 Z	5,022	4,612	216.3	823	741	10.0	10.0	300	275.6	189,690	189,690	26.24
LD 604 A	5,223	4,709	213.0	879	773	9.6	8.8	317	271.5	207,010	207,010	27.61
LD 604	5,379	4,850	219.3	879	773	10.0	9.0	317	279.4	213,276	213,276	27.63
LD 605 N	6,085	5,573	246.3	901	791	12.0	9.5	324	313.8	251,195	251,195	28.29
LD 605 KN	6,346	5,817	256.8	902	791	12.6	10.0	325	327.1	262,422	262,422	28.32
LD 606 A	6,359	5,850	256.2	906	794	13.4	9.0	326	326.4	264,870	264,870	28.49
LD 606 N	7,041	6,483	282.3	909	796	15.4	9.8	327	359.6	294,669	294,669	28.63
LD 628	7,664	7,083	305.4	929	809	16.3	10.1	332	389.0	329,063	329,063	29.08
LD 607 A	8,004	7,453	318.6	921	806	17.7	10.0	330	406.0	343,170	343,170	29.07
LD 607	8,478	7,898	337.2	923	807	19.0	10.6	331	429.5	364,602	364,602	29.14
LD 607 K	8,822	8,223	350.4	925	808	20.0	11.0	331	446.3	380,300	380,300	29.19

1. Further (special) sections on request
2. Steel plates can be additionally welded on to increase the static values

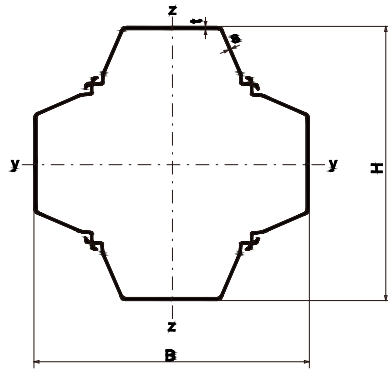

terra Infrastructure p LV

Pile sections	Section modulus W_y cm^3	Section modulus W_z cm^3	Weight kg/m	b mm	H mm	Dimensions t mm	s mm	Perimeter cm	Area Steel cross section cm^2	Moment of inertia I_y cm^4	Moment of inertia I_z cm^4	Radius of gyration $min.i$ cm
LV 601		5,335	185.2	968	968	7.5	6.4	369	236.0		258,198	33.08
LV 602		6,145	213.6	971	971	8.4	7.6	369	272.0		298,312	33.12
LV 603		7,744	256.8	986	986	9.6	8.2	397	327.1		381,896	34.17
LV 603 Z		8,684	288.4	993	993	10.0	10.0	398	367.4		431,074	34.25
LV 604 A		8,718	284.0	1,059	1,059	9.6	8.8	421	362.0		461,491	35.70
LV 604		8,982	292.4	1,059	1,059	10.0	9.0	421	372.6		475,644	35.73
LV 605 N		10,211	328.4	1,092	1,092	12.0	9.5	430	418.5		557,375	36.49
LV 605 KN		10,656	342.4	1,093	1,093	12.6	10.0	431	436.2		582,398	36.54
LV 606 A		10,695	341.6	1,099	1,099	13.4	9.0	432	435.2		587,726	36.75
LV 606 N		11,863	376.4	1,103	1,103	15.4	9.8	433	479.5		654,278	36.94
LV 628		12,920	407.2	1,125	1,125	16.3	10.1	441	518.7		726,613	37.43
LV 607 A		13,517	424.8	1,124	1,124	17.7	10.0	438	541.3		759,384	37.46
LV 607		14,329	449.6	1,126	1,126	19.0	10.6	439	572.6		806,845	37.54
LV 607 K		14,919	467.2	1,128	1,128	20.0	11.0	440	595.1		841,559	37.61

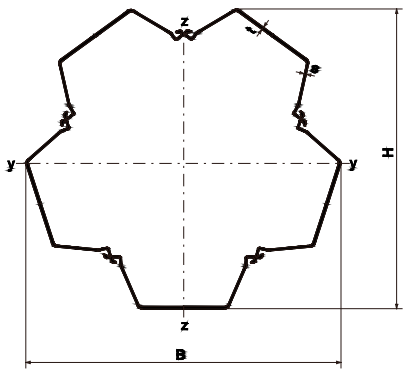

terra Infrastructure LF

LF 604 A	13,176	12,645	355.0	1,352	1,290	9.6	8.8	524	452,5	856.845	854.275	43.45
LF 604	13,524	12,966	365.5	1,352	1,290	10.0	9.0	524	465,5	879.595	876.751	43.40
LF 605 N	15,409	14,859	410.5	1,379	1,314	12.0	9.5	532	523,0	1.024.299	1.024.823	44.26
LF 605 KN	16,069	15,486	428.0	1,379	1,314	12.6	10.0	532	545,5	1.068.055	1.068.090	44.25
LF 606 A	16,087	15,508	427.0	1,382	1,318	13.4	9.0	537	544,0	1.075.901	1.071.598	44.38
LF 606 N	17,885	17,304	470.5	1,386	1,323	15.4	9.8	537	599,5	1.200.892	1.197.124	44.69
LF 628	19,455	18,763	509.0	1,406	1,345	16.3	10.1	545	648,5	1.330.228	1.319.432	45.11
LF 607 A	20,462	19,754	531.0	1,401	1,340	17.7	10.0	544	676,5	1.395.953	1.384.162	45.23
LF 607	21,637	20,975	562.0	1,404	1,342	19.0	10.6	544	716,0	1.478.955	1.472.440	45.35
LF 607 K	22,539	21,869	584.0	1,406	1,344	20.0	11.0	544	744,0	1.543.947	1.537.415	45.46

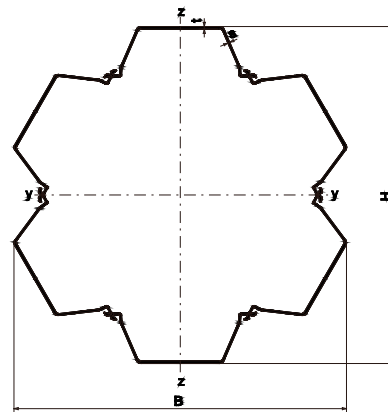

terra Infrastructure LS

LS 604 A	18,121	18,962	426.0	1,504	1,535	9.6	8.8	632	543,0	1.390.812	1.425.933	50.61
LS 604	18,589	19,476	438.6	1,504	1,535	10.0	9.0	632	558,6	1.427.288	1.464.623	50.55
LS 605 N	21,220	22,397	492.6	1,530	1,561	12.0	9.5	638	627,6	1.665.526	1.713.384	51.36
LS 605 KN	22,139	23,345	513.6	1,530	1,561	12.6	10.0	638	654,6	1.727.179	1.785.918	51.37
LS 606 A	22,198	23,191	512.4	1,536	1,569	13.4	9.0	643	652,8	1.745.858	1.767.140	51.71
LS 606 N	24,686	26,021	564.6	1,540	1,571	15.4	9.8	643	719,4	1.938.243	2.002.728	51.91
LS 628	26,879	28,165	610.8	1,556	1,596	16.3	10.1	654	778,2	2.144.918	2.191.217	52.50
LS 607 A	28,182	29,642	637.2	1,548	1,592	17.7	10.0	650	811,8	2.244.228	2.294.323	52.58
LS 607	29,841	31,434	674.4	1,552	1,595	19.0	10.6	650	859,2	2.379.842	2.439.270	52.63
LS 607 K	31,090	32,782	700.8	1,554	1,597	20.0	11.0	650	892,8	2.482.569	2.547.128	52.73

1. Further (special) sections on request
2. Steel plates can be additionally welded on to increase the static values

Combined sheet pile walls

Pipe pile wall
with LPB 180-12 connector

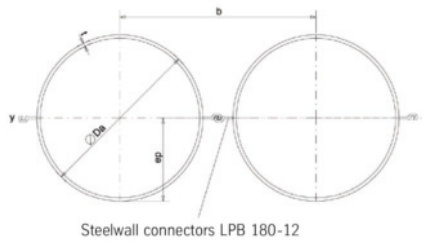

Pipe diameter	Wall thickness	Width	Moment of inertia	Section modulus	Edge distance	Dead load related to pipe length - Length of connector LPB 180 as % of pipe length	Coating area
Da mm	t mm	b (m)	I _y cm ⁴ /m	W _y cm ³ /m	ep cm	100% kg/m ²	Water site m ² /m
813	10.00	0.993	204,797	5,038	40.65	228.63	1.50
813	12.00	0.993	243,942	6,001	40.65	267.92	1.50
813	14.00	0.993	282,496	6,949	40.65	307.01	1.50
819	10.00	0.999	208,164	5,083	40.95	228.74	1.50
819	12.00	0.999	247,966	6,055	40.95	268.09	1.50
819	14.00	0.999	287,172	7,013	40.95	307.24	1.50
914	10.00	1.094	265,217	5,803	45.70	230.29	1.50
914	12.00	1.094	316,170	6,918	45.70	270.51	1.50
914	14.00	1.094	366,440	8,018	45.70	310.54	1.50
1,016	10.00	1.196	334,322	6,581	50.80	231.68	1.51
1,016	12.00	1.196	398,817	7,851	50.80	272.68	1.51
1,016	14.00	1.196	462,535	9,105	50.80	313.50	1.51
1,220	12.00	1.400	593,413	9,728	61.00	276.07	1.52
1,220	14.00	1.400	688,907	11,294	61.00	318.13	1.52
1,220	16.00	1.400	783,444	12,843	61.00	360.06	1.52
1,420	14.00	1.600	955,140	13,453	71.00	321.52	1.53
1,420	16.00	1.600	1,086,970	15,309	71.00	364.37	1.53
1,420	18.00	1.600	1,217,666	17,150	71.00	407.10	1.53
1,620	16.00	1.800	1,440,667	17,786	81.00	367.73	1.53
1,620	18.00	1.800	1,614,739	19,935	81.00	411.19	1.53
1,620	20.00	1.800	1,787,496	22,068	81.00	454.54	1.53
1,820	18.00	2.000	2,068,284	22,728	91.00	414.46	1.53
1,820	20.00	2.000	2,290,504	25,170	91.00	458.41	1.53
1,820	22.00	2.000	2,511,231	27,596	91.00	502.26	1.53
1,820	25.00	2.000	2,839,537	31,204	91.00	567.84	1.53

Pipe / sheet pile wall with tkL 603 double pile intermediate piles I

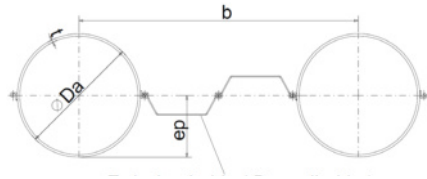

Intermediate pile tkL 603 double pile

Pipe diameter Da mm	Wall thickness t mm	Width b m	Including intermediate piles		Excluding intermediate piles		Edge distance ep cm	Deadweight related to pipe length - pipe length			Coating area Water side m ² /m
			Moment of inertia I _y cm ⁴ /m	Section modulus W _y cm ³ /m	Moment of inertia I _y cm ⁴ /m	Section modulus W _y cm ³ /m		Length of connector as % of pipe length	60%	80%	
813	10.00	2,073	109,216	2,687	98,101	2,413	40.65	138.83	153.26	167.70	1.41
813	12.00	2,073	127,967	3,148	116,852	2,875	40.65	157.65	172.08	186.52	1.41
813	14.00	2,073	146,434	3,602	135,320	3,329	40.65	176.37	190.81	205.24	1.41
819	10.00	2,079	111,109	2,713	100,027	2,443	40.95	139.14	153.53	167.92	1.41
819	12.00	2,079	130,235	3,180	119,153	2,910	40.95	158.05	172.44	186.83	1.41
819	14.00	2,079	149,074	3,640	137,992	3,370	40.95	176.86	191.25	205.64	1.41
914	10.00	2,174	144,060	3,152	133,462	2,920	45.70	143.84	157.60	171.36	1.42
914	12.00	2,174	169,701	3,713	159,103	3,481	45.70	164.07	177.84	191.60	1.42
914	14.00	2,174	194,998	4,267	184,400	4,035	45.70	184.22	197.98	211.75	1.42
1,016	10.00	2,276	185,804	3,658	175,681	3,458	50.80	148.44	161.59	174.73	1.43
1,016	12.00	2,276	219,694	4,325	209,571	4,125	50.80	169.98	183.13	196.27	1.43
1,016	14.00	2,276	253,177	4,984	243,054	4,785	50.80	191.44	204.58	217.73	1.43
1,220	12.00	2,480	344,281	5,644	334,991	5,492	61.00	180.34	192.41	204.47	1.44
1,220	14.00	2,480	398,189	6,528	388,899	6,375	61.00	204.09	216.16	228.22	1.44
1,220	16.00	2,480	451,557	7,403	442,267	7,250	61.00	227.76	239.82	251.89	1.44
1,420	14.00	2,680	578,830	8,153	570,233	8,031	71.00	214.63	225.79	236.95	1.45
1,420	16.00	2,680	657,534	9,261	648,937	9,140	71.00	240.21	251.37	262.54	1.45
1,420	18.00	2,680	735,562	10,360	726,965	10,239	71.00	265.72	276.88	288.04	1.45
1,620	16.00	2,880	908,417	11,215	900,417	11,116	81.00	250.93	261.32	271.71	1.46
1,620	18.00	2,880	1,017,212	12,558	1,009,212	12,459	81.00	278.09	288.48	298.87	1.46
1,620	20.00	2,880	1,125,185	13,891	1,117,185	13,792	81.00	305.18	315.57	325.96	1.46
1,820	18.00	3,080	1,350,522	14,841	1,343,041	14,759	91.00	288.86	298.57	308.29	1.46
1,820	20.00	3,080	1,494,821	16,427	1,487,340	16,344	91.00	317.39	327.11	336.82	1.46
1,820	22.00	3,080	1,638,150	18,002	1,630,669	17,919	91.00	345.87	355.58	365.30	1.46
1,820	25.00	3,080	1,851,336	20,344	1,843,855	20,262	91.00	388.46	398.17	407.88	1.46

Other intermediate piles on request

Pipe / sheet pile wall with tkL 603 triple pile intermediate piles

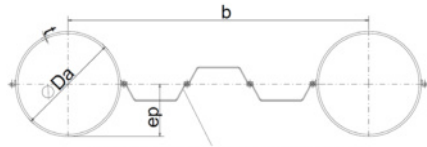

Intermediate pile tkL 603 triple pile

Pipe diameter Da mm	Wall thickness t mm	Width b m	Including intermediate piles		Excluding intermediate piles		Edge distance ep cm	Dead load related to pipe length - to pipe length - connector as % of pipe length			Coating area Water side m ² /m
			Moment of inertia I _y cm ⁴ /m	Section modulus W _y cm ³ /m	Moment of inertia I _y cm ⁴ /m	Section modulus W _y cm ³ /m		60%	80%	100%	
813	10.00	2,673	88,000	2,165	76,081	1,872	40.65	122.08	138.07	154.07	1.38
813	12.00	2,673	102,542	2,523	90,623	2,229	40.65	136.67	152.67	168.67	1.38
813	14.00	2,673	116,864	2,875	104,945	2,582	40.65	151.19	167.19	183.19	1.38
819	10.00	2,679	89,517	2,186	77,625	1,896	40.95	122.36	138.32	154.28	1.39
819	12.00	2,679	104,359	2,548	92,467	2,258	40.95	137.03	152.99	168.95	1.39
819	14.00	2,679	118,979	2,905	107,086	2,615	40.95	151.63	167.59	183.55	1.39
914	10.00	2,774	116,080	2,540	104,595	2,289	45.70	126.61	142.03	157.44	1.39
914	12.00	2,774	136,175	2,980	124,690	2,728	45.70	142.47	157.89	173.30	1.39
914	14.00	2,774	156,001	3,414	144,515	3,162	45.70	158.26	173.68	189.09	1.39
1,016	10.00	2,876	150,108	2,955	139,030	2,737	50.80	130.87	145.74	160.60	1.40
1,016	12.00	2,876	176,928	3,483	165,850	3,265	50.80	147.91	162.78	177.65	1.40
1,016	14.00	2,876	203,426	4,004	192,348	3,786	50.80	164.89	179.76	194.63	1.40
1,220	12.00	3,080	280,077	4,591	269,733	4,422	61.00	157.72	171.60	185.48	1.41
1,220	14.00	3,080	323,484	5,303	313,139	5,133	61.00	176.84	190.72	204.61	1.41
1,220	16.00	3,080	366,455	6,007	356,111	5,838	61.00	195.90	209.78	223.66	1.41
1,420	14.00	3,280	475,635	6,699	465,922	6,562	71.00	187.11	200.15	213.18	1.42
1,420	16.00	3,280	539,943	7,605	530,229	7,468	71.00	208.01	221.05	234.08	1.42
1,420	18.00	3,280	603,697	8,503	593,983	8,366	71.00	228.85	241.89	254.93	1.42
1,620	16.00	3,480	754,328	9,313	745,173	9,200	81.00	218.73	231.02	243.31	1.43
1,620	18.00	3,480	844,365	10,424	835,210	10,311	81.00	241.21	253.50	265.79	1.43
1,620	20.00	3,480	933,722	11,527	924,567	11,414	81.00	263.63	275.92	288.21	1.43
1,820	18.00	3,680	1,132,725	12,448	1,124,067	12,352	91.00	252.23	263.85	275.47	1.44
1,820	20.00	3,680	1,253,497	13,775	1,244,839	13,680	91.00	276.11	287.73	299.35	1.44
1,820	22.00	3,680	1,373,457	15,093	1,364,799	14,998	91.00	299.94	311.56	323.18	1.44
1,820	25.00	3,680	1,551,884	17,054	1,543,226	16,959	91.00	335.59	347.21	358.83	1.44

Other intermediate piles on request

Pipe / sheet pile wall with Hoesch 1807 double pile intermediate piles

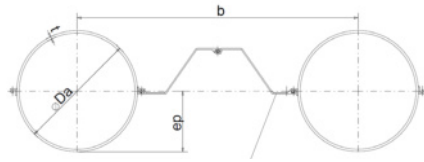

Intermediate pile Hoesch 1807 double pile

Pipe diameter Da mm	Wall thickness t mm	Width b m	Including intermediate piles		Excluding intermediate piles		Edge distance ep cm	Dead load related to pipe length - connector as % of pipe length			Coating area Wasser side m ² /m
			Moment of inertia I _y cm ⁴ /m	Section modulus W _y cm ³ /m	Moment of inertia I _y cm ⁴ /m	Section modulus W _y cm ³ /m		Length of connector 60% kg/m ²	80% kg/m ²	100% kg/m ²	
813	10.00	2,273	112,875	2,777	89,469	2,201	40.65	132.47	147.59	162.71	1.38
813	12.00	2,273	129,976	3,197	106,570	2,622	40.65	149.64	164.75	179.87	1.38
813	14.00	2,273	146,819	3,612	123,413	3,036	40.65	166.72	181.83	196.95	1.38
819	10.00	2,279	114,593	2,798	91,249	2,228	40.95	132.77	147.85	162.93	1.38
819	12.00	2,279	132,040	3,224	108,696	2,654	40.95	150.02	165.10	180.18	1.38
819	14.00	2,279	149,226	3,644	125,882	3,074	40.95	167.19	182.26	197.34	1.38
914	10.00	2,374	144,629	3,165	122,219	2,674	45.70	137.33	151.80	166.28	1.39
914	12.00	2,374	168,109	3,679	145,699	3,188	45.70	155.86	170.34	184.81	1.39
914	14.00	2,374	191,275	4,185	168,865	3,695	45.70	174.31	188.78	203.26	1.39
1,016	10.00	2,476	182,977	3,602	161,490	3,179	50.80	141.83	155.71	169.59	1.40
1,016	12.00	2,476	214,130	4,215	192,643	3,792	50.80	161.63	175.51	189.39	1.40
1,016	14.00	2,476	244,908	4,821	223,422	4,398	50.80	181.35	195.23	209.11	1.40
1,220	12.00	2,680	329,843	5,407	309,992	5,082	61.00	171.86	184.68	197.50	1.41
1,220	14.00	2,680	379,728	6,225	359,877	5,900	61.00	193.83	206.65	219.47	1.41
1,220	16.00	2,680	429,113	7,035	409,262	6,709	61.00	215.73	228.55	241.37	1.41
1,420	14.00	2,880	549,106	7,734	530,633	7,474	71.00	204.35	216.28	228.21	1.42
1,420	16.00	2,880	622,345	8,765	603,872	8,505	71.00	228.15	240.08	252.01	1.42
1,420	18.00	2,880	694,953	9,788	676,481	9,528	71.00	251.89	263.82	275.75	1.42
1,620	16.00	3,080	859,221	10,608	841,948	10,394	81.00	238.96	250.11	261.27	1.43
1,620	18.00	3,080	960,951	11,864	943,678	11,650	81.00	264.36	275.51	286.67	1.43
1,620	20.00	3,080	1,061,914	13,110	1,044,641	12,897	81.00	289.69	300.85	312.00	1.43
1,820	18.00	3,280	1,277,368	14,037	1,261,149	13,859	91.00	275.31	285.78	296.26	1.44
1,820	20.00	3,280	1,412,868	15,526	1,396,649	15,348	91.00	302.10	312.58	323.05	1.44
1,820	22.00	3,280	1,547,458	17,005	1,531,238	16,827	91.00	328.84	339.31	349.79	1.44
1,820	25.00	3,280	1,747,645	19,205	1,731,425	19,027	91.00	368.83	379.31	389.78	1.44

Other intermediate piles on request

Pipe / sheet pile wall with Hoesch 1907 double pile intermediate piles

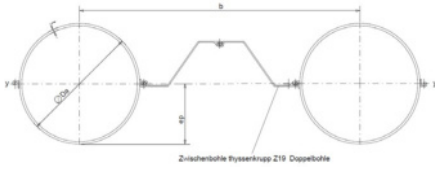

Intermediate pile Hoesch 1907 double pile

Pipe diameter Da mm	Wall thickness t mm	Width b m	Including intermediate piles		Excluding intermediate piles			Edge distance ep cm	Dead load related to pipe length - to pipe length - Length of connector as % of pipe length			Coating area Water side m ² /m
			Moment of inertia I _y cm ⁴ /m	Section modulus W _y cm ³ /m	Moment of inertia I _y cm ⁴ /m	Section modulus W _y cm ³ /m	60%		80%	100%		
											kg/m ²	
813	10.00	2,273	113,846	2,801	89,469	2,201	40.65	134.32	150.05	165.79	1.38	
813	12.00	2,273	130,947	3,221	106,570	2,622	40.65	151.49	167.22	182.95	1.38	
813	14.00	2,273	147,790	3,636	123,413	3,036	40.65	168.56	184.30	200.03	1.38	
819	10.00	2,279	115,562	2,822	91,249	2,228	40.95	134.62	150.31	166.00	1.38	
819	12.00	2,279	133,009	3,248	108,696	2,654	40.95	151.87	167.56	183.25	1.38	
819	14.00	2,279	150,195	3,668	125,882	3,074	40.95	169.03	184.72	200.41	1.38	
914	10.00	2,374	145,559	3,185	122,219	2,674	45.70	139.10	154.16	169.22	1.39	
914	12.00	2,374	169,039	3,699	145,699	3,188	45.70	157.63	172.69	187.76	1.39	
914	14.00	2,374	192,205	4,206	168,865	3,695	45.70	176.08	191.14	206.21	1.39	
1,016	10.00	2,476	183,869	3,619	161,490	3,179	50.80	143.53	157.97	172.41	1.40	
1,016	12.00	2,476	215,022	4,233	192,643	3,792	50.80	163.33	177.77	192.21	1.40	
1,016	14.00	2,476	245,800	4,839	223,422	4,398	50.80	183.05	197.49	211.94	1.40	
1,220	12.00	2,680	330,667	5,421	309,992	5,082	61.00	173.42	186.77	200.11	1.41	
1,220	14.00	2,680	380,552	6,239	359,877	5,900	61.00	195.40	208.74	222.08	1.41	
1,220	16.00	2,680	429,937	7,048	409,262	6,709	61.00	217.30	230.64	243.98	1.41	
1,420	14.00	2,880	549,872	7,745	530,633	7,474	71.00	205.80	218.22	230.64	1.42	
1,420	16.00	2,880	623,112	8,776	603,872	8,505	71.00	229.61	242.03	254.44	1.42	
1,420	18.00	2,880	695,720	9,799	676,481	9,528	71.00	253.35	265.76	278.18	1.42	
1,620	16.00	3,080	859,938	10,617	841,948	10,394	81.00	240.32	251.93	263.54	1.43	
1,620	18.00	3,080	961,668	11,872	943,678	11,650	81.00	265.72	277.33	288.94	1.43	
1,620	20.00	3,080	1,062,631	13,119	1,044,641	12,897	81.00	291.05	302.66	314.28	1.43	
1,820	18.00	3,280	1,278,042	14,044	1,261,149	13,859	91.00	276.59	287.49	298.39	1.44	
1,820	20.00	3,280	1,413,542	15,533	1,396,649	15,348	91.00	303.38	314.28	325.19	1.44	
1,820	22.00	3,280	1,548,131	17,012	1,531,238	16,827	91.00	330.12	341.02	351.92	1.44	
1,820	25.00	3,280	1,748,318	19,212	1,731,425	19,027	91.00	370.11	381.01	391.92	1.44	

Other intermediate piles on request

Cold-rolled sheet piling sections *

Trench sheeting

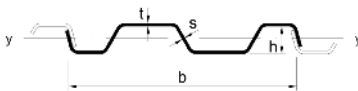
Trench sheeting sections		Section modulus W_y cm^3/m	Weight Wall kg/m^2	Weight Single pile kg/m	Moment of inertia I_y cm^4/m	Width b mm	Height h mm	Flange thickness t mm	Web thickness s mm
	KD VI/6	184	62.00	37.50	718	600	78	6.0	6.0
	KD VI/8	237	83.00	50.00	947	600	80	8.0	8.0
	KD VI/9	263	92.55	55.53	1,066	600	81	9.0	9.0

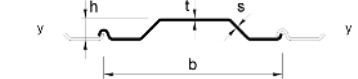
Trench sheeting sections		Section modulus W_y cm^3/m	Weight Wall kg/m^2	Weight Single pile kg/m	Moment of inertia I_y cm^4/m	Width b mm	Height h mm	Flange thickness t mm	Web thickness s mm
	KD 4/5	84	46.30	18.52	208	400	49	5.0	5.0
	KD 4/6	99	55.57	22.23	250	400	50	6.0	6.0

Lightweight sections		Section modulus W_y cm^3/m	Weight Wall kg/m^2	Weight Single pile kg/m	Moment of inertia I_y cm^4/m	Width b mm	Height h mm	Flange thickness t mm	Web thickness s mm
	FLP 700-4	276	44.85	31.40	2,061	700	147	4.0	4.0
	FLP 700-5	343	56.20	39.40	2,576	700	148	5.0	5.0
	FLP 700-6	409	66.90	47.20	3,084	700	149	6.0	6.0
	FLP 700-7	474	77.60	54.34	3,591	700	150	7.0	7.0
	FLP 700-8	540	88.45	61.90	4,100	700	151	8.0	8.0

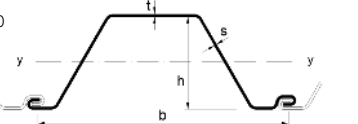
Lightweight sections		Section modulus W_y cm^3/m	Weight Wall kg/m^2	Weight Single pile kg/m	Moment of inertia I_y cm^4/m	Width b mm	Height h mm	Flange thickness t mm	Web thickness s mm
	FLP 750-6	788	76.60	57.46	11,375	750	283	6.0	6.0
	FLP 750-7	912	89.30	67.00	13,263	750	284	7.0	7.0
	FLP 750-8	1,044	102.00	76.60	15,170	750	285	8.0	8.0

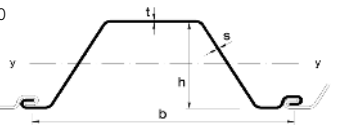
Lightweight sections		Section modulus W_y cm^3/m	Weight Wall kg/m^2	Weight Single pile kg/m	Moment of inertia I_y cm^4/m	Width b mm	Height h mm	Flange thickness t mm	Web thickness s mm
	FLP 840-6	617	68.40	57.46	7,832	840	250	6.0	6.0
	FLP 840-7	718	79.76	67.00	9,128	840	251	7.0	7.0
	FLP 840-8	817	91.20	76.61	10,474	840	252	8.0	8.0

* Only on request

Lightweight Z sections

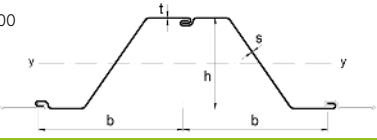
ZP 700		Section modulus	Weight	Weight	Moment	Width	Height	Flange	Web
		W_y cm ³ /m	Wall kg/m ²	Single pile kg/m	of inertia I_y cm ⁴ /m	b mm	h mm	thickness t mm	thickness s mm
ZP 700-6		1,289	72.85	51.00	28,351	700	440	6.0	6.0
ZP 700-7		1,500	85.00	59.50	33,060	700	441	7.0	7.0
ZP 700-8		1,709	97.14	68.00	37,765	700	442	8.0	8.0

Lightweight Z sections

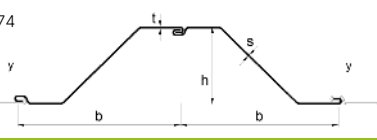
ZP 774		Section modulus	Weight	Weight	Moment	Width	Height	Flange	Web
		W_y cm ³ /m	Wall kg/m ²	Single pile kg/m	of inertia I_y cm ⁴ /m	b mm	h mm	thickness t mm	thickness s mm
ZP 774-6		982	65.90	51.00	18,436	774	375	6.0	6.0
ZP 774-7		1,142	76.90	59.50	21,497	774	376	7.0	7.0
ZP 774-8		1,300	87.90	68.00	24,555	774	377	8.0	8.0

Lightweight Z sections

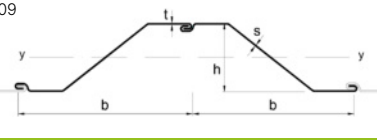
ZP 809		Section modulus	Weight	Weight	Moment	Width	Height	Flange	Web
		W_y cm ³ /m	Wall kg/m ²	Single pile kg/m	of inertia I_y cm ⁴ /m	b mm	h mm	thickness t mm	thickness s mm
ZP 809-6		830	63.00	51.00	13,905	809	335	6.0	6.0
ZP 809-7		965	73.50	59.50	16,213	809	336	7.0	7.0
ZP 809-8		1,100	84.00	68.00	18,518	809	337	8.0	8.0

Technical data

Forms of supply for trench sheeting

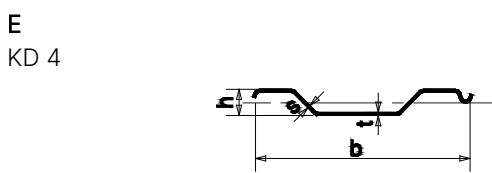
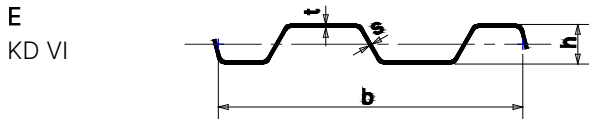

Trench sheeting is only supplied as single piles (S) with handling holes..

Forms of supply for KL lightweight sections

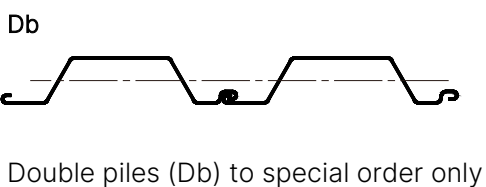
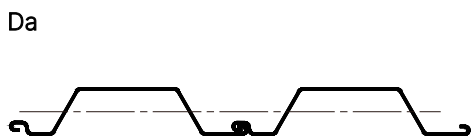
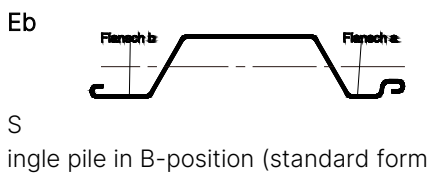
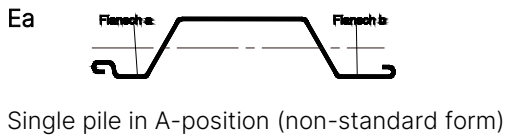

Handling holes, KD VI trench sheets

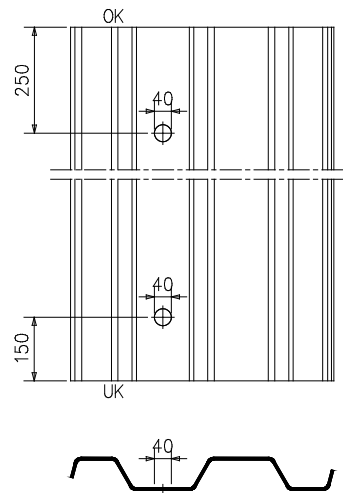

Handling holes KD VI and KD 4 trench sheets
250 mm from top edge
150 mm from bottom edge, standard form

Handling holes KL lightweight sections

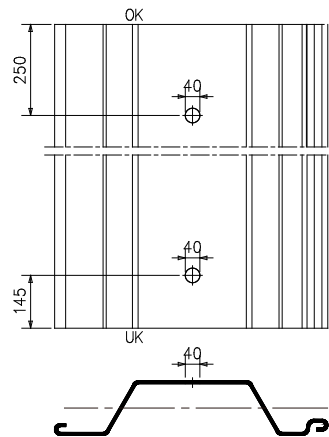

The KL lightweight sections are supplied with handling holes. Handling holes are provided at both ends according to the above drawing.

Terms of delivery and steel grades

Terms of delivery

The terms of delivery and tolerances for hot-rolled steel sheet piles are in accordance with DIN EN 10248. Cold-rolled sheet piles are supplied in steel grade S 275 JR to DIN EN 10249.

Excerpt from the tolerances for form and dimensions for hot-rolled sheet piling made from unalloyed steels to DIN EN 10248-2

Wall thickness U-sections	t: $\leq 8.5 \text{ mm} = \pm 0.5 \text{ mm}$; $> 8.5 \text{ mm} = \pm 6 \% t$ s: $\leq 8.5 \text{ mm} = -0.5 \text{ mm}$; $> 8.5 \text{ mm} = -6 \% s^*$
Wall thickness, Z-sections and straight-web sections	t, s: $\leq 8.5 \text{ mm} = \pm 0.5 \text{ mm}$; $> 8.5 \text{ mm} = \pm 6 \% s, t$
Section width	Single pile $\pm 2 \%$, double pile $\pm 3 \%$
Section length	Lengths of sections may deviate by $\pm 200 \text{ mm}$ from ordered lengths
Section height, U-sections	$\leq 200 \text{ mm} = \pm 4 \text{ mm}$; $> 200 \text{ mm} = \pm 5 \text{ mm}$
Section height, Z-sections	$\leq 200 \text{ mm} = \pm 5 \text{ mm}$; from 200 to 300 mm = $\pm 6 \text{ mm}$; $> 300 \text{ mm} = \pm 7 \text{ mm}$
Weight	max. $\pm 5\%$ margin between calculated weight (according to section tables) and measured weight of total delivery

* Positive tolerances are usually a matter for the manufacturer's discretion. Positive tolerances can be agreed upon placing an order. In this case the following values should be used: $+0.5 \text{ mm}$ for $s < 8.5 \text{ mm}$ and $+6\%$ of s for $s > 8.5 \text{ mm}$

Excerpt from the tolerances for form and dimensions for cold-rolled sheet piling made from unalloyed steels to DIN EN 10249-2

Wall thickness for nominal width up to 1,200 mm	from 4.00 to 5.00 mm = $\pm 0.24 \text{ mm}$; from 5.00 to 6.00 mm = $\pm 0.26 \text{ mm}$; from 6.00 to 8.00 mm = $\pm 0.29 \text{ mm}$
Wall thickness for nominal width 1,200 to 1,500 mm	from 4.00 to 5.00 mm = $\pm 0.26 \text{ mm}$; from 5.00 to 6.00 mm = $\pm 0.28 \text{ mm}$; from 6.00 to 8.00 mm = $\pm 0.30 \text{ mm}$
Section width	Single pile $\pm 2 \%$, double pile $\pm 3 \%$
Section length	Lengths of sections may deviate by $\pm 50 \text{ mm}$ from ordered lengths
Section height	$\leq 200 \text{ mm}$ section height $\pm 4 \text{ mm}$
Weight	max. $\pm 7\%$ margin between calculated weight (according to section tables) and measured weight of total delivery

All information without guarantee.
Errors and changes excepted

Steel grade

The steel grades used for our hot-rolled steel sheet piles comply with DIN EN 10248-1 and for our cold-rolled sheet piles DIN EN 10249-1..

Hot-rolled sheet piling sections to DIN EN 10248-1

Steel grade	Tensile strength N/mm ²	Minimum yield strength N/mm ²	Minimum elongation %
S 270 GP	410	270	24
S 355 GP	480	355	22
S 390 GP	490	390	20
S 430 GP	510	430	19

Steel grades for cold-rolled trench sheeting and lightweight sections to DIN EN 10249-1

Steel grade	Tensile strength N/mm ²	Minimum yield strength N/mm ²	Minimum elongation %
S 275 JR	410	275	23
S 355 JO	470	355	22

Standardized steels for combined sheet piling

Steel grade	Standard
General structural steels	EN 10025
Fine-grain structural steels	EN 10113
Weathering steels	EN 10155
Steels for sheet piling	EN 10248
Special steels, PT series	PT material standard
Special works steels with minimum yield strengths of 355 to 460 N/mm ²	
Further steels on request	e.g. BS, NF, ASTM, JIS, CSAG, GOST, UNI

All section dimensions can be supplied to current national and international standards, also to customer specification if required. A selection can be found in the "steel grades" table.

Interlocks

Corner and junction piles for U- and Z-piles *

SteelWall® connectors for U- and Z-piles

Interlocks in S 355

LVO

Weight: 13.85 kg/m

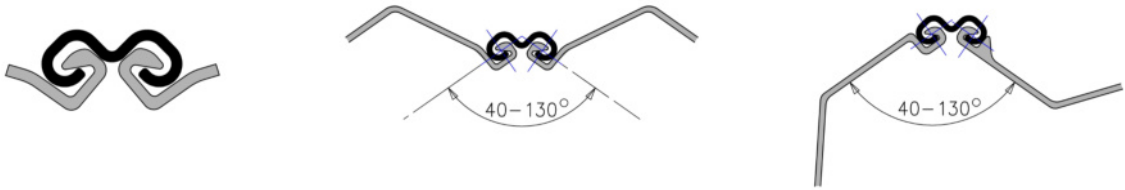

LVO_n

Weight: 13.91 kg/m³

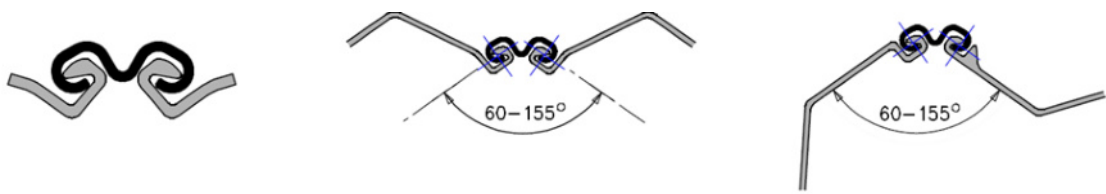

LV20_n

Weight: 14.07 kg/m

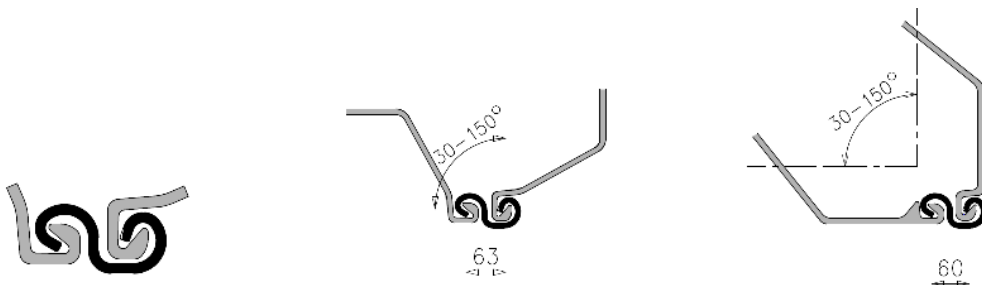

LV22

Weight: 8.0 kg/m

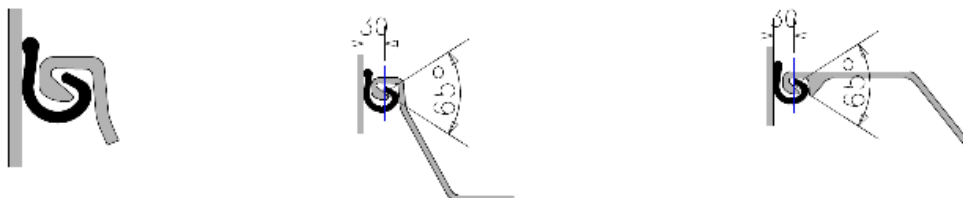

* Corner piles are connected to sheet piles in accordance with DIN EN 12063 and are not suitable for single driving.

"SteelWall®" is a trademark of SteelWall ISH GmbH, Germany.

Corner and junction piles for U- and Z-piles *

Corner and junction piles for U- and Z-piles

Omega 17

Weight: 17.30 kg/m

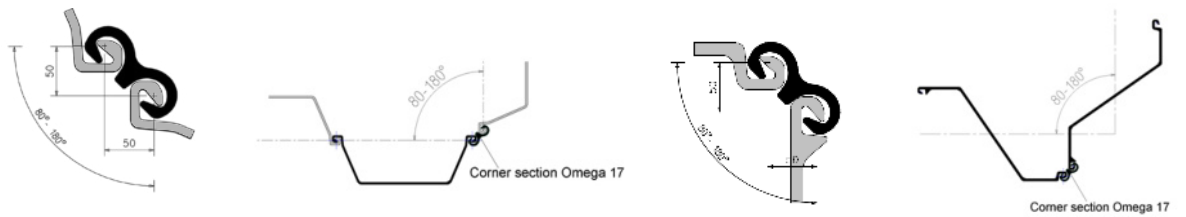

Corner section 20

Weight: 16.50 kg/m

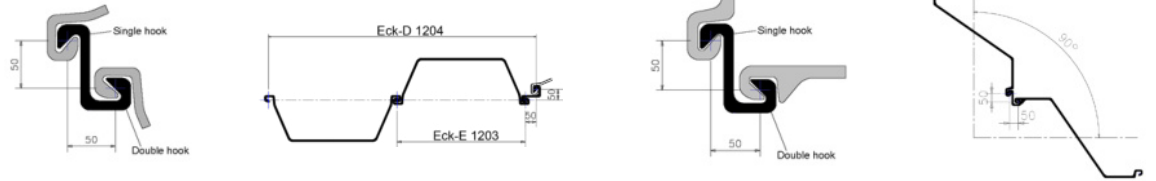

Corner section 22

Weight: 9.20 kg/m

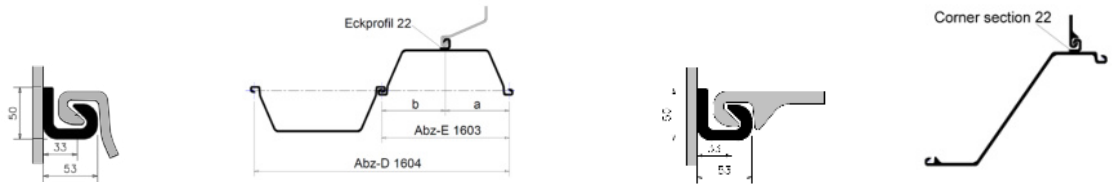

Folded corner pile



Corner and junction piles for U- and Z-piles, traditional *

SteelWall® connectors for U- and Z-piles, traditional

LOT

Weight: 18.0 kg/m

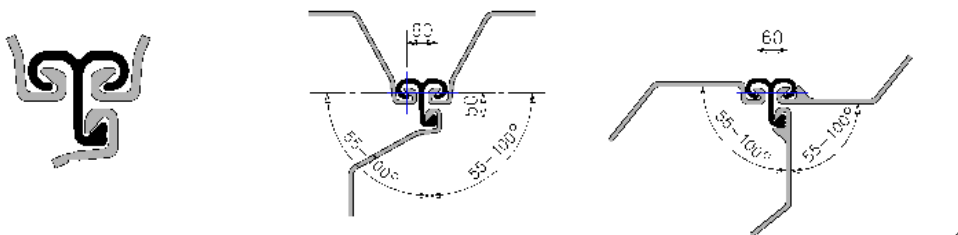

LT

Weight: 17.6 kg/m

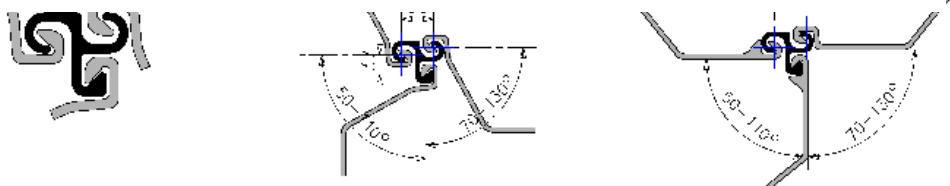

LV-Omega

Weight: 14.0 kg/m

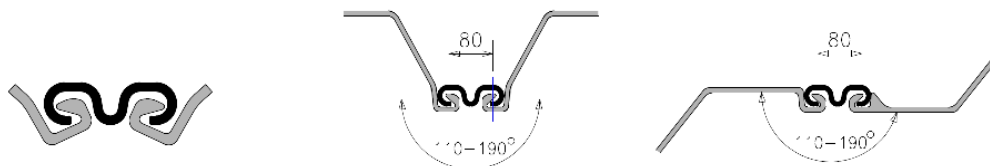

* Corner piles are connected to the sheet piles in accordance with DIN EN 12063 and are not suitable for single driving.

"SteelWall®" is a trademark of SteelWall ISH GmbH, Germany.

Corner and junction piles for U- and Z-piles, universal *
SteelWall® connectors for U- and Z-piles, universal, Interlocks in S 355

LS90
 Weight: 12.70 kg/m

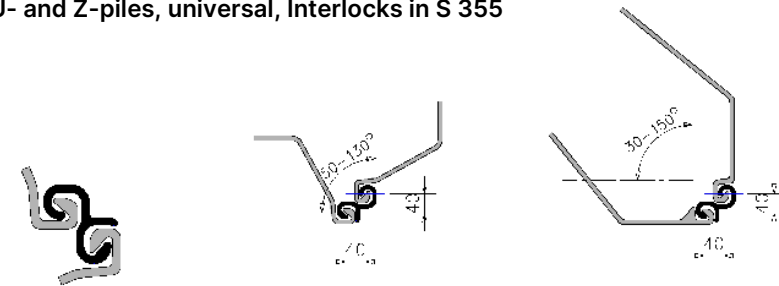

LTO
 Weight: 19.80 kg/m

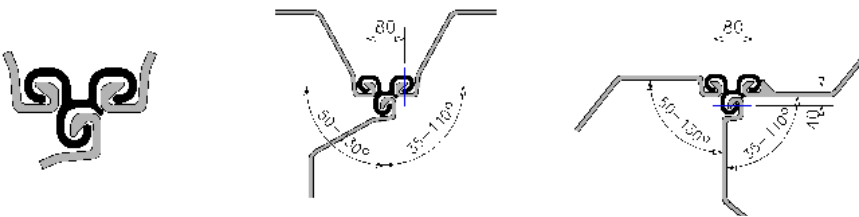

LTS
 Weight: 19.00 kg/m

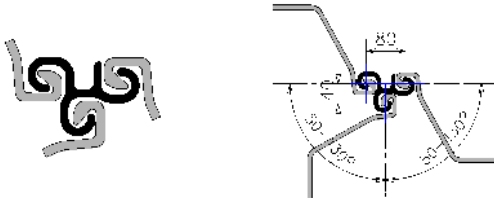

LTZ
 Weight: 19.00 kg/m

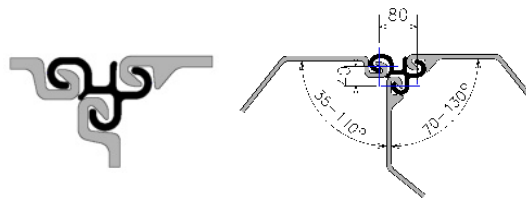

Corner and junction piles for cold rolled sheet piles *
SteelWall® connectors for cold rolled sheet piles, Interlocks in S 355

CF 90
 Weight: 17.50 kg/m



CF-Junction
 Weight: 8.90 kg/m



CFT
 Weight: 25.80 kg/m



* Corner piles are connected to the sheet piles in accordance with DIN EN 12063 and are not suitable for single driving.
 "SteelWall®" is a trademark of SteelWall ISH GmbH, Germany.

Sealing systems

Interlock sealing system

terra infrastructure

Guiding

When installing sheet piles with sealed interlocks, particular attention must be paid to guiding to ensure the piles do not lean to the front, rear or side. Any corrective measures applied must not cause any narrowing of any interlock slots containing profiled seals. DIN EN 12063 and EAU 2020 contain useful advice.



profiled seal



interlock bevelled



Driving direction

When installing sections with sealed interlocks, the direction of driving must be specified prior to starting work. When pitching double piles on-site, make sure that the free interlock is driven first and the interlock with the seal is threaded into this. For threading, the pile must be turned so that the unsealed interlock points in the direction of driving. The side with the

sealant is to be indicated by a colored dot at the top of the pile. Sheet piling should normally be driven continuously. However, staggered installation is also possible. The method used should be chosen on the basis of the overall driving conditions.

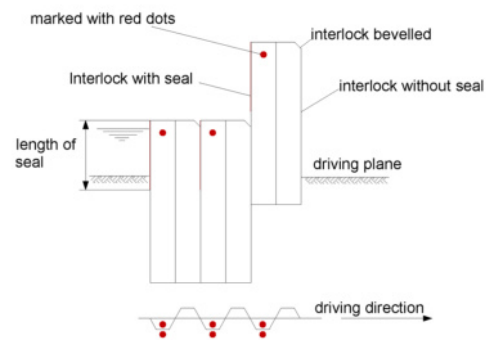

U-Section



Interlock with profiled seal



Middle interlock with injected seal



Z-Section

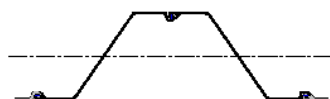

Interlock with profiled seal



Interlock with profiled seal



Middle interlock with injected seal



Lightweight sections

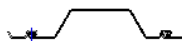

Interlock with profiled seal



Factory-threaded interlock with seal



Bitumen-based interlock fillers

Material properties

Bituminous-based seals are an elastomeric bitumen hot-poured sealant. After application and cooling, this material may be anything from soft to stiff depending on the ambient temperature. It adheres well to the steel surface.

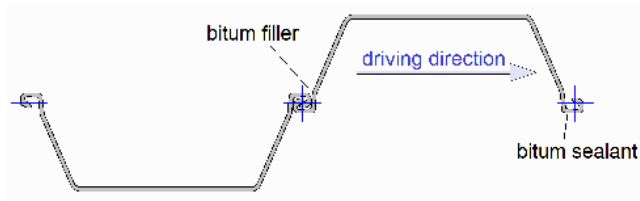

Direction of driving

The direction of driving must be specified prior to installation when filled interlocks are involved. For threading, the pile must be turned so that the filled interlock points in the direction of driving.

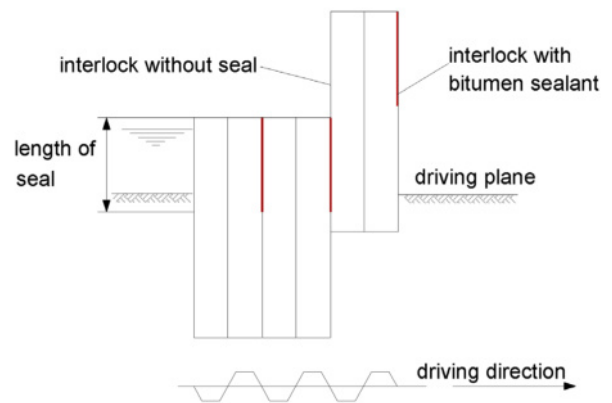

Interlock with bitumen

U-Section

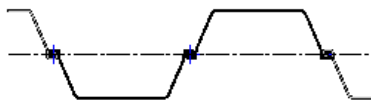

Interlock with bitumen sealant



Middle interlock with bitumen sealant



U-Profil

Z-Section



Interlock with bitumen sealant



Middle interlock with bitumen sealant



Z-Profil

Lightweight section



Interlock with bitumen sealant



Leichtprofil

Other sealing methods and installation advice.

Other sealing and installation methods may be necessary depending on the requirements of the particular project. It is therefore essential to investigate and establish the methods to be used in advance.

The following additional sealing methods are available for interlocks that must be sealed after driving:

Where sealing requirements are not excessive, interlocks can be sealed subsequently, e.g. with timber wedges (swelling effect), rubber, or plastic cords.

If absolute watertightness is required, welding the interlocks is the only solution. As a rule, this concerns the threading interlocks only because factory-threaded interlocks can be welded prior to driving. It is important to note that the interlock can only be welded when the surfaces are dry and clean. The weld must be applied to the side of the sheet piling that faces the base of the structure to be erected. Open interlocks can be covered with, for instance, steel flats or steel sections attached to the sheet piling with fillet welds.

Effect of high temperatures

Welding carried out near seals or fillers can be expected to have an adverse, local effect on these materials. If subsequent welding cannot be avoided, resealing will be necessary.

Criteria for selecting a suitable interlock sealing system.

Which interlock seal is suitable for which project? This question has to be considered for every new project, and the answer depends on the project specification and the boundary conditions. We can provide you with the information you need so that you can specify “your” system spot-on.

Example: vertical wall 10.5 m deep is required to encapsulate contaminated site. Investigations have revealed that the soil is contaminated with the following hazardous substances: chlorinated dioxins and furans, chlorobenzenes, chlorophenols, oils, mineral oils, polycyclic aromatic hydrocarbons, aliphatic and aromatic solvents.

From this it follows that the wall required must be resistant to all of the aforementioned substances. The permeability required is $k \leq 1,0 \cdot 10^{-9}$ m/s for a notional thickness of $d = 60$ cm. In light of the quality requirements, only factory-sealed sheet piles are permissible. The section modulus required is $W_y \geq 1,100$ cm³/m. A suitable sealing system can now be determined based on the following parameters:

Permeability criteria

The interlock seepage resistance $\rho \leq k \cdot b/d$

The result is that to achieve the equivalent of a 60 cm thick diaphragm wall with $k \leq 1,0 \cdot 10^{-9}$ m/s the minimum requirement is single piles with a terra infrastructure interlock sealing system in the threading interlock (critical pile width ≥ 0.50 m).

Spot-on selection

The following calculation models are based on DIN EN 12063:

Seepage resistance ρ (m/s)

$$\rho = \frac{q(z) \cdot \gamma}{\Delta p(z)}$$

where:

- $q(z)$ = discharge rate over time related to interlock length ($m^3/m \cdot s$)
- γ = specific gravity of fluid (kN/m^3)
- $\Delta p(z)$ = hydrostatic pressure (kN/m^2)

Seepage rate Q ($m^3/s \cdot interlock$)

$$Q = \int_0^{\Delta h+h} q(z) \cdot dz = (\rho/\gamma) \cdot \int_0^{\Delta h+h} \Delta p(z) \cdot dz$$

The seepage rate Q through a lock can be calculated by:

$$Q = \rho \cdot \Delta h \cdot (0,5 \cdot \Delta h + h)$$

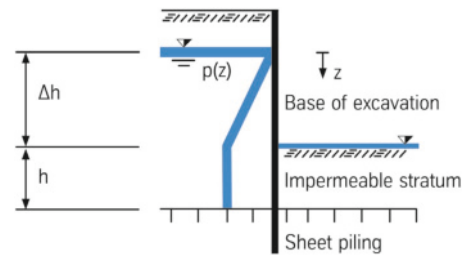

where:

- k = permeability coefficient (m/s)
- Q = measured flow rate (m^3/s)
- i = hydraulic gradient (-)
- A = cross-sectional area, wall area (m^2)

To compare the imperviousness with that of a diaphragm wall, the permeability coefficient k to DIN 18130 Part 1 for soils (porous media) can be taken into account:

$$k = \frac{Q}{i \cdot A} \rightarrow Q = \frac{k \cdot \Delta p(z)}{\gamma \cdot d} \cdot A$$

Considering these fundamental relationships and the number of critical interlocks per m^2 of wall area results in this relationship for a constant seepage rate Q :

$$\frac{k \cdot \Delta p(z)}{\gamma \cdot d} = \frac{\rho \cdot \Delta p(z)}{\gamma \cdot b}$$

where:

- d = thickness of diaphragm wall (m)
- b = critical element width for designing seepage rate (m)

$$\rightarrow \frac{k}{d} = \frac{\rho}{b}$$

Sections	Critical element width m	Comparable k-value for 60 cm thick diaphragm wall m/s	Leakage requirement satisfied	Imperviousness requirement satisfied
EB (500-er)	0.50	$2.2 \cdot 10^{-10}$	yes	yes
DB (500-er)	1.00	$1.1 \cdot 10^{-10}$	yes	yes
EB (600-er)	0.60	$1.8 \cdot 10^{-10}$	yes	yes
DB (600-er)	1.20	$9.0 \cdot 10^{-11}$	yes	yes

A double pile (600 series) with $W_y \geq 1.100 \text{ cm}^3/m$ is selected for economic reasons. Its imperviousness therefore compares with that of a 60 cm thick diaphragm wall with a k-value of $9.0 \cdot 10^{-11} \text{ m/s}$, or for an 80 cm thick diaphragm wall a k-value of $1.2 \cdot 10^{-10} \text{ m/s}$. Due to its lower thickness, a slurry wall must exhibit a k-value of $1.2 \cdot 10^{-11} \text{ m/s}$ in order to achieve the imperviousness of the sheet piling solution.

Resistance criteria

Conventional bituminous interlock fillers are not resistant to pollutants such as aliphatic and aromatic solvents, oils, or mineral oils. However, the terra infrastructure interlock sealing system has proven to be resistant to these pollutants.

Comparison of k-values *

Sealing system	Critical element width b (m)	ρ m/s	k-value required for diaphragm		Slurry wall
			d = 0,60 m	d = 0,80 m	d = 0,080 m
Single piles with bitumen compound in every interlock	0.50	$6.0 \cdot 10^{-8}$	$7.2 \cdot 10^{-8}$	$9.6 \cdot 10^{-8}$	$9.6 \cdot 10^{-9}$
	0.60		$6.0 \cdot 10^{-8}$	$8.0 \cdot 10^{-8}$	$8.0 \cdot 10^{-9}$
Double piles with bitumen compound in driving interlock and poured compound in middle interlock	1.00	$6.0 \cdot 10^{-8}$	$3.6 \cdot 10^{-8}$	$4.8 \cdot 10^{-8}$	$4.8 \cdot 10^{-9}$
	1.20		$3.0 \cdot 10^{-8}$	$4.0 \cdot 10^{-8}$	$4.0 \cdot 10^{-9}$
Single piles with terra infrastructure interlock sealing system in every interlock	0.50	$1.8 \cdot 10^{-10}$	$2.2 \cdot 10^{-10}$	$2.9 \cdot 10^{-10}$	$2.9 \cdot 10^{-11}$
	0.60		$1.8 \cdot 10^{-10}$	$2.4 \cdot 10^{-10}$	$2.4 \cdot 10^{-11}$
Double piles with terra infrastructure interlock sealing system in threading interlock and injected sealant in middle interlock	1.00	$1.8 \cdot 10^{-10}$	$1.1 \cdot 10^{-10}$	$1.4 \cdot 10^{-10}$	$1.4 \cdot 10^{-11}$
	1.20		$9.0 \cdot 10^{-10}$	$1.2 \cdot 10^{-10}$	$1.2 \cdot 10^{-11}$
Triple piles with terra infrastructure interlock sealing system in the threading interlock and injected sealant in the middle interlocks	1.50	$1.8 \cdot 10^{-10}$	$7.2 \cdot 10^{-11}$	$9.6 \cdot 10^{-11}$	$9.6 \cdot 10^{-12}$
	1.80		$6.0 \cdot 10^{-11}$	$8.0 \cdot 10^{-11}$	$8.0 \cdot 10^{-12}$

	ρ m/s	Critical element width for double pile m	No. of interlocks with possibly limited seepage	Ingress into excavation		Reduction in quantity of water to be pumped
				l/s	%	%
Groundwater lowering with steel sheet pile wall				~ 115	100	+
Sheet piling without interlock sealing	$8.0 \cdot 10^{-4}$ $\times k_{\text{soil}}/b$	0.5	900	~ 41	36	64
Sheet piling with site-applied bitumen compound in every interlock	$6.0 \cdot 10^{-8}$	0.5	900	~ 3,1	3	97
Sheet piling with factory-applied bitumen compound in driving interlock and poured compound in middle interlock	$6.0 \cdot 10^{-8}$	1	450	~ 1,5	1,3	99
Sheet piling with terra infrastructure interlock sealing system in threading interlock and injected sealant in middle interlock	$1.8 \cdot 10^{-10}$	1	450	~ 0.005	0.004	99.9

* The table values given here are for information only and represent a theoretical tightness.

Wide Flange Beam HEA and HEB

According to DIN 1025-3 / EN 10365, Tolerances according to EN 10034

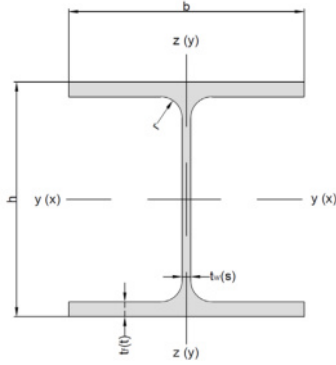

Section designation HEA	Trade weight kg/m	Depth h mm	Width b mm	Web thickness s mm	Flange thickness t mm	Elastic section modulus Wy cm ³	Moment of inertia Iy cm ⁴
100	17.10	96	100	5.0	8.0	72.8	349
120	20.40	114	120	5.0	8.0	106	606
140	25.30	133	140	5.5	8.5	155	1,033
160	31.20	152	160	6.0	9.0	220	1,673
180	36.40	171	180	6.0	9.5	294	2,510
200	43.00	190	200	6.5	10.0	389	3,692
220	52.00	210	220	7.0	11.0	515	5,410
240	62.00	230	240	7.5	12.0	675	7,763
260	70.00	250	260	7.5	12.5	836	10,455
280	78.00	270	280	8.0	13.0	1,013	13,673
300	90.00	290	300	8.5	14.0	1,260	18,263
320	100.00	310	300	9.0	15.5	1,479	22,929
340	108.00	330	300	9.5	16.5	1,678	27,693
360	115.00	350	300	10.0	17.5	1,891	33,090
400	128.00	390	300	11.0	19.0	2,311	45,069
450	143.00	440	300	11.5	21.0	2,896	63,722
500	159.00	490	300	12.0	23.0	3,550	86,975
550	170.00	540	300	12.5	24.0	4,146	111,930
600	182.00	590	300	13.0	25.0	4,787	141,210
650	195.00	640	300	13.5	26.0	5,474	175,180
700	209.00	690	300	14.5	27.0	6,241	215,300
800	230.00	790	300	15.0	28.0	7,682	303,440
900	258.00	890	300	16.0	30.0	9,485	422,070
1,000	279.00	990	300	16.5	31.0	11,189	553,850

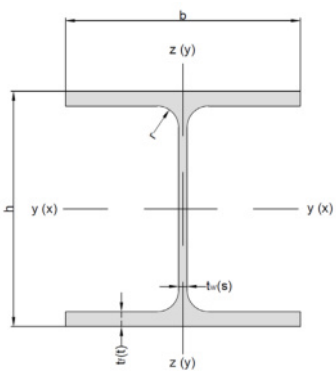

Section designation HEB	Trade weight kg/m	Depth h mm	Width b mm	Web thickness s mm	Flange thickness t mm	Elastic section modulus Wy cm ³	Moment of inertia Iy cm ⁴
100	20.9	100	100	6.0	10.0	89.9	450
120	27.4	120	120	6.5	11.0	144	864
140	34.5	140	140	7.0	12.0	216	1,509
160	43.7	160	160	8.0	13.0	312	2,492
180	52.5	180	180	8.5	14.0	426	3,831
200	63.0	200	200	9.0	15.0	570	5,696
220	73.0	220	220	9.5	16.0	736	8,091
240	85.0	240	240	10.0	17.0	938	11,259
260	95.0	260	260	10.0	17.5	1,148	14,919
280	106.0	280	280	10.5	18.0	1,376	19,270
300	120.0	300	300	11.0	19.0	1,678	25,166
320	130.0	320	300	11.5	20.5	1,926	30,824
340	137.0	340	300	12.0	21.5	2,156	36,656
360	146.0	360	300	12.5	22.5	2,400	43,193
400	159.0	400	300	13.5	24.0	2,884	57,680
450	175.0	450	300	14.0	26.0	3,551	79,888
500	192.0	500	300	14.5	28.0	4,287	107,180
550	204.0	550	300	15.0	29.0	4,971	136,690
600	217.0	600	300	15.5	30.0	5,701	171,040
650	231.0	650	300	16.0	31.0	6,480	210,620
700	247.0	700	300	17.0	32.0	7,340	256,890
800	269.0	800	300	17.5	33.0	8,977	359,080
900	298.0	900	300	18.5	35.0	10,979	494,060
1,000	322.0	1,000	300	19.0	36.0	12,895	644,750

Wide Flange Beam HEM

According to DIN 1025-4 / EN 10365 - Tolerances according to EN 10034

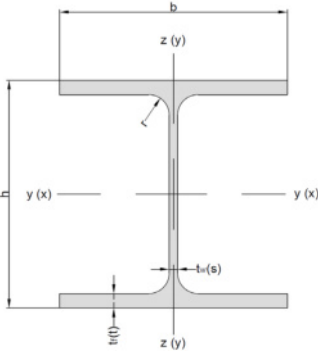

Section designation HEM	Trade weight kg/m	Dept h h mm	Width b mm	Web thickness s mm	Flange thickness t mm	Elastic section modulus Wy cm ³	Moment of inertia Iy cm ⁴
100	42.80	120	106	12.0	20.0	190	1,143
120	53.40	140	126	12.5	21.0	288	2,018
140	64.80	160	146	13.0	22.0	411	3,291
160	78.10	180	166	14.0	23.0	567	5,098
180	91.10	200	186	14.5	24.0	748	7,483
200	106.00	220	206	15.0	25.0	967	10,642
220	120.00	240	226	15.5	26.0	1,217	14,605
240	161.00	270	248	18.0	32.0	1,799	24,289
260	176.00	290	268	18.0	32.5	2,159	31,307
280	194.00	310	288	18.5	33.0	2,551	39,547
300	244.00	340	310	21.0	39.0	3,482	59,201
320	251.00	359	309	21.0	40.0	3,796	68,135
340	254.00	377	309	21.0	40.0	4,052	76,372
360	256.00	395	308	21.0	40.0	4,297	84,867
400	262.00	432	307	21.0	40.0	4,820	104,120
450	270.00	478	307	21.0	40.0	5,501	131,480
500	277.00	524	306	21.0	40.0	6,180	161,930
550	285.00	572	306	21.0	40.0	6,923	197,980
600	292.00	620	305	21.0	40.0	7,660	237,450
650	300.00	668	305	21.0	40.0	8,433	281,670
700	309.00	716	304	21.0	40.0	9,198	329,280
800	325.00	814	303	21.0	40.0	10,875	442,600
900	341.00	910	302	21.0	40.0	12,537	570,430
1,000	358.00	1,008	302	21.0	40.0	14,331	722,300

Standard steel grade S235 Other steel grades on request

Double U Sections

According to EN 10365 *Tolerances according to EN 10279 *

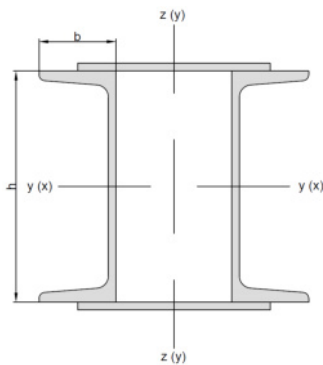

Section designation UU	Double U Trade weight g kg/m	Depth h mm	Width b mm	Elastic section modulus Wy cm ³	Moment of inertia ly cm ⁴
80	18.7	80	45	26.5	105.9
100	22.9	100	50	41.1	205.3
120	28.8	120	55	60.7	364.3
140	34.5	140	60	86.4	604.8
160	40.6	160	65	115.6	924.7
180	47.3	180	70	150.4	1,354
200	54.6	200	75	191.1	1,911
220	63.0	220	80	244.7	2,691
240	71.4	240	85	299.9	3,599
260	83.0	260	90	371.1	4,824
280	90.3	280	95	448.3	6,276
300	100.8	300	100	535.2	8,028
320	128.1	320	100	679.3	10,870
350	130.2	340	100	734.0	12,840
380	136.5	360	102	829.2	15,760
400	155.4	400	110	1,018.0	20,350

* Single U Section Standard steel grade S235 Other steel grades on request

Steel plates and sheets

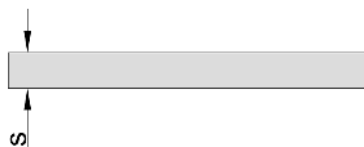

Stärke s mm	Gewicht g kg/m ²	2000 x 3000* kg/Stk	2000 x 4000* kg/Stk	2000 x 6000* kg/Stk
15	120	720	960	1.440
20	160	960	1.280	1.920
22	176	1.056	1.408	2.112
25	200	1.200	1.600	2.400
30	240	1.440	1.920	2.880

* Other Dimension on request

Standard steel grade S235 Other steel grades on request

terra infrastructure GmbH, Hollestr. 7a, 45127 Essen, Germany
T: +49 201 5657832110
info@terra-infrastructure.com | www.terra-infrastructure.com

Australia

terra infrastructure Pty Ltd, 11 Woodford Pl, Thornton NSW 2322, Australia
P: +61 2 8448-3555
Info.anz@terra-infrastructure.com
www.terra-infrastructure.com.au

New Zealand

terra infrastructure Pty Ltd, 180 Fred Taylor Drive, Whenuapai Auckland 0814, New Zealand
P: +64 9 416-8891
Info.anz@terra-infrastructure.com
www.terra-infrastructure.co.nz

Baltic States

terra infrastructure UAB, Liepų g. 83, 93269 Klaipėda, Lithuania
P: +370 46 355-401
www.terra-infrastructure.com/lt

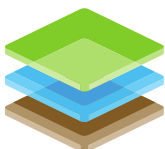

terra
infrastructure